

ELEVAH65MOVE

| N° | Codice | Descrizione |
|----|----------|----------------------------|
| 1 | 2CARH65R | Carro base completo |
| 2 | 2TRAL65E | Traliccio ELEVAH65MOVE |
| 3 | 2CARTERZ | Copri-zavorre |
| 4 | 2MANOP6Z | Manopola zigrinata nera m6 |
| 5 | 2CURVA.F | Curva filettata |
| 6 | 2PRE1351 | Pressacavo in metallo |

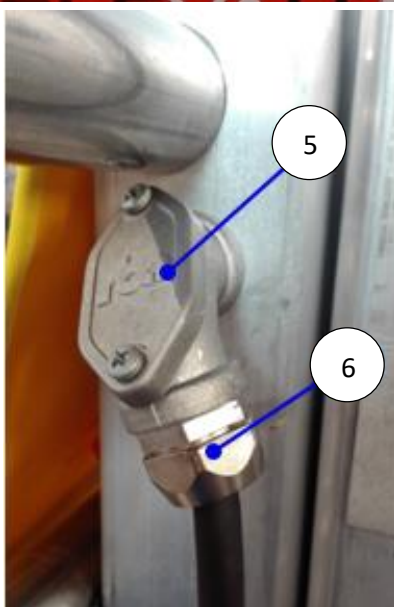
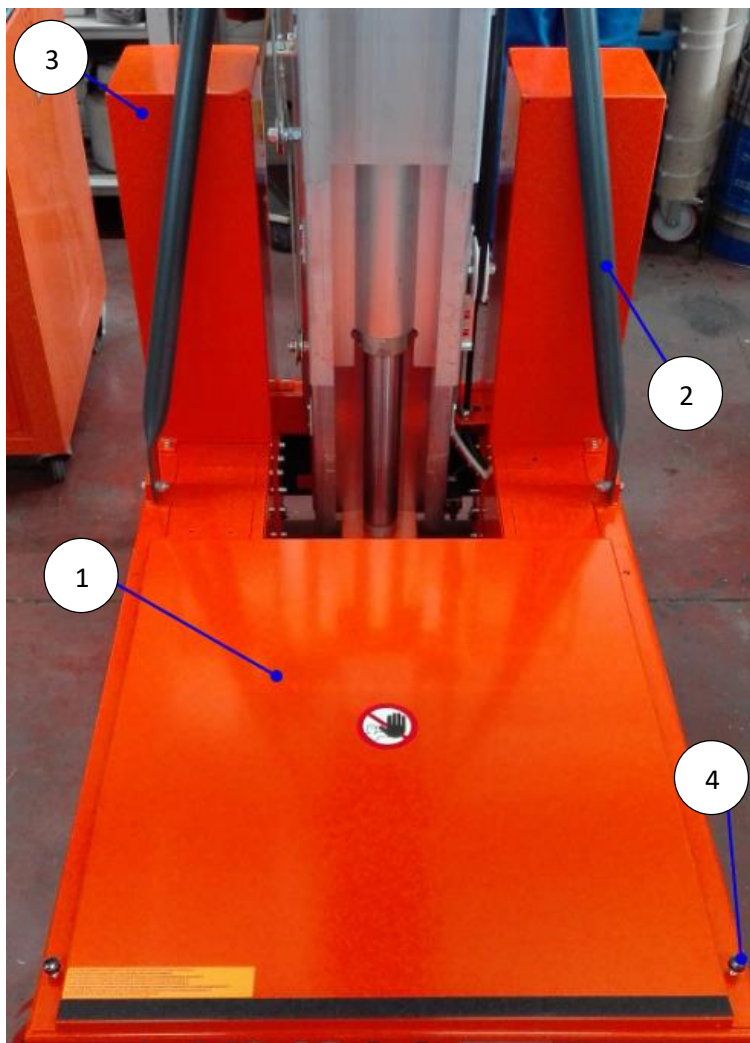

ELEVAH65MOVE

| N° | Codice | Descrizione |
|----|----------|--------------------------------|
| 7 | SSFO0651 | 1° sfilo carrello ELEVAH65MOVE |
| 8 | SSFO0652 | 2° sfilo carrello ELEVAH65MOVE |
| 9 | SSFO0653 | 3° sfilo carrello ELEVAH65MOVE |
| 10 | SSFO0654 | 4° sfilo carrello ELEVAH65MOVE |
| 11 | SSFO0655 | 5° sfilo carrello ELEVAH65MOVE |
| 12 | ZTAPPO | TAPPO Kit.car |
| 13 | 2PUL4010 | Puleggia guida cavo |
| 14 | 2SQUASTR | Squadretta tipo "Stretto" |
| 15 | 2SQUALAR | Squadretta tipo "Largo" |
| 16 | 2CAV1600 | Cavetti di richiamo |

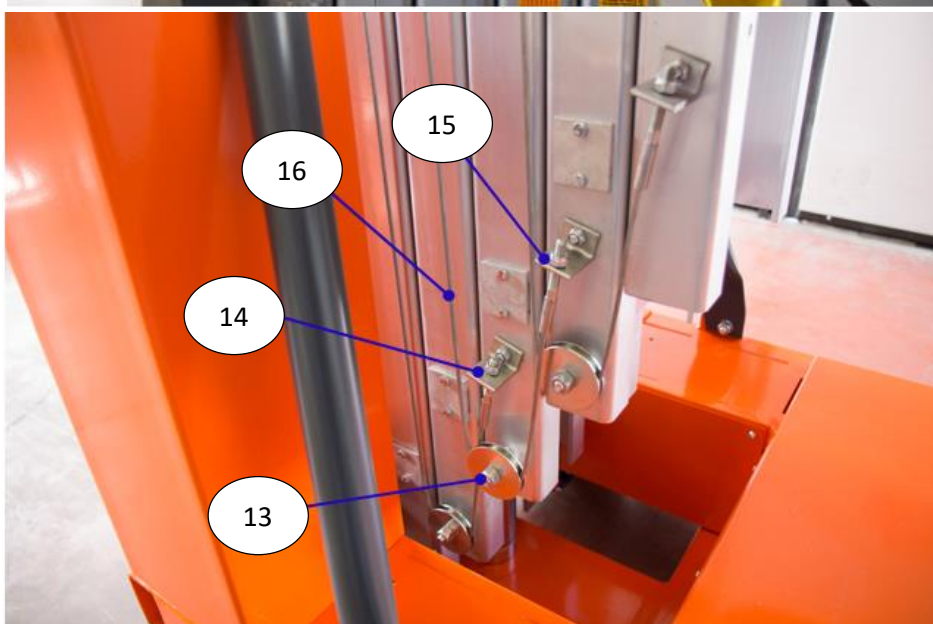
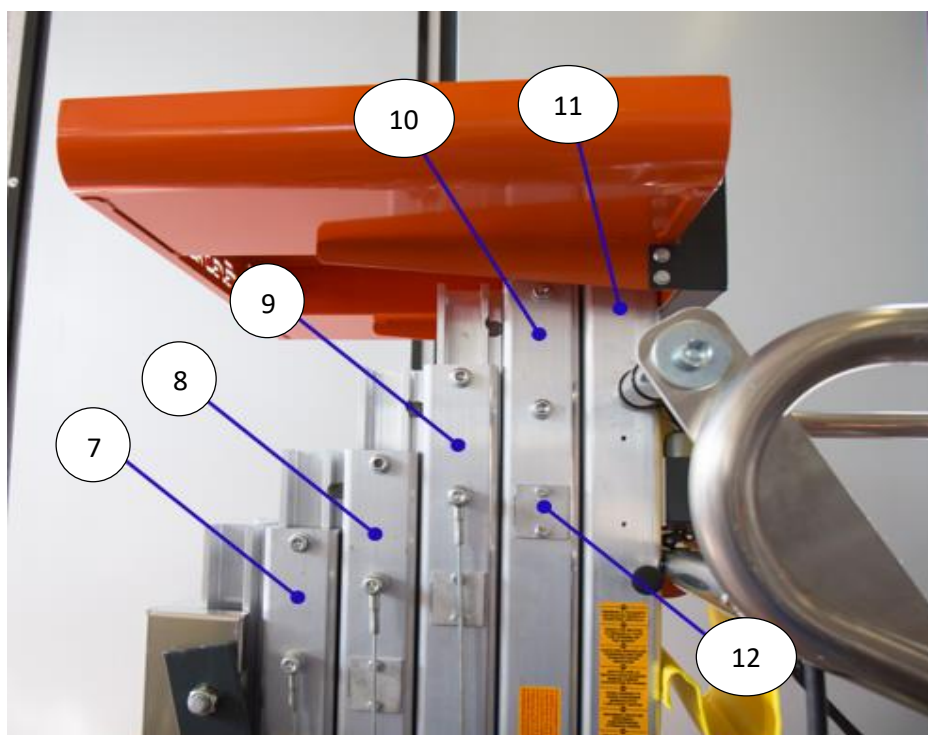

ELEVAH65MOVE

| N° | Codice | Descrizione |
|----|----------|----------------------------------|
| 17 | KITCAR50 | Kit carrello di scorrimento d.50 |
| 18 | KITCAR30 | Kit carrello di scorrimento d.30 |



ELEVAH65MOVE

| N° | Codice | Descrizione |
|----|----------|--|
| 19 | 2PIASTRA | Piastra attacco catene 2° sfilo |
| 20 | 2CATF544 | Coppia catene 1° sfilo |
| 21 | 2CATF544 | Coppia catene 2° sfilo |
| 22 | 2CATF544 | Coppia catene 3° sfilo |
| 23 | 2PUL6829 | Pulegge catene secondo sfilo |
| 24 | 2PUL5029 | Pulegge catene |
| 25 | 2SUPPCEN | Supporto centrale |
| 26 | 2DISTA02 | Distanziale laterale da mm.13,5 |
| 27 | 2SUPPLAT | Supporto laterale |
| 28 | 2SUPLATF | Supporto laterale filettato |
| 29 | 2DISTA03 | Distanziale laterale da mm.12,5 |
| 30 | 2PERNO04 | Perno puleggia laterale |
| 31 | 2PERNO03 | Perno puleggia centrale |
| 32 | *** | Tappo cilindro (fa parte del cilindro) |
| 33 | 2STELOPK | Stelo colonna |
| 34 | *** | Guida stelo (fa parte dello stelo) |
| 35 | 2KIT.GUA | Kit. guarnizioni complete ghiera |
| 36 | 2PERNO05 | Perno catena completo di coppiglie |
| 37 | 2PETTINI | Pettine attacco catena |

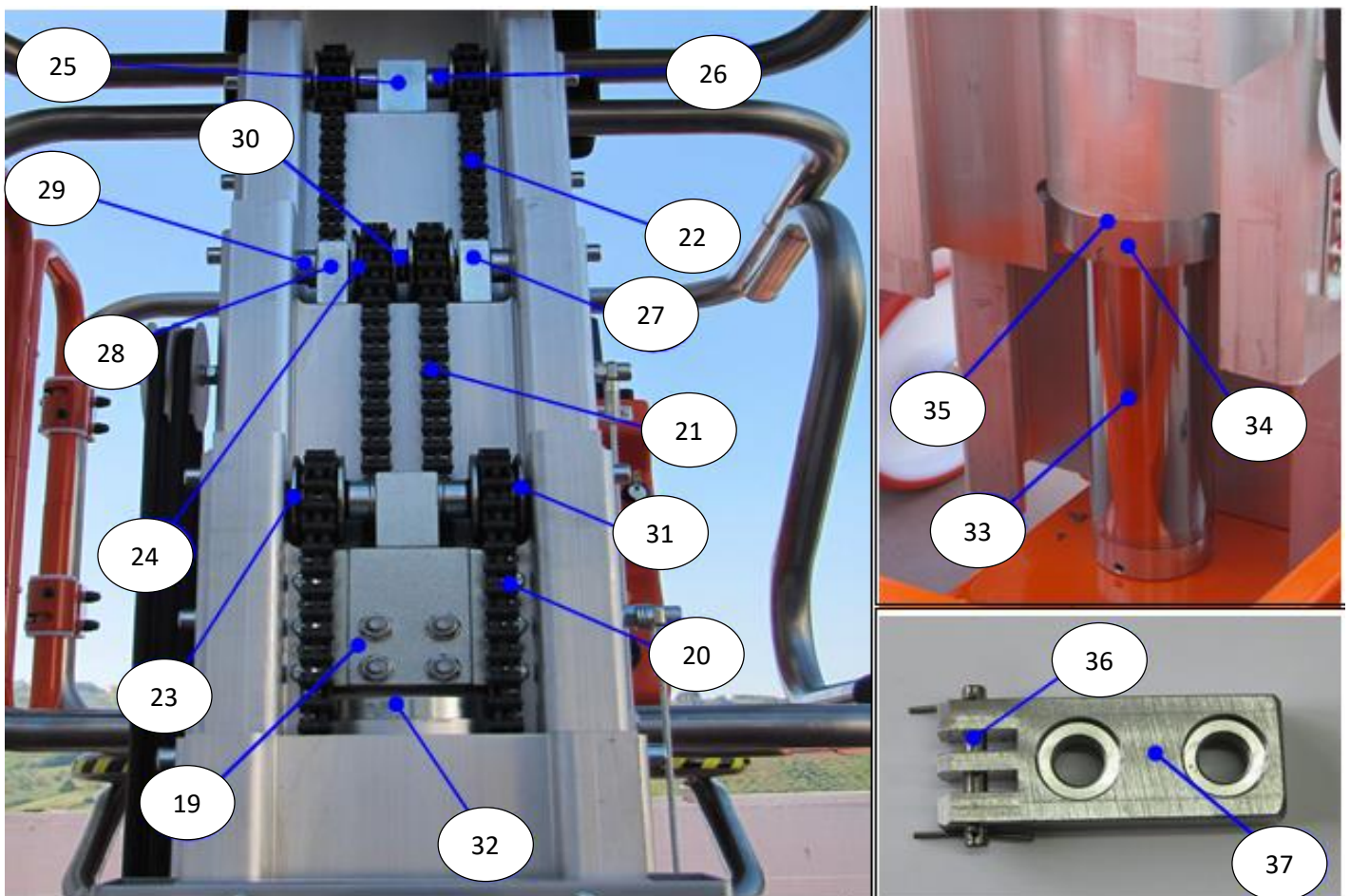

ELEVAH65MOVE

| N° | Codice | Descrizione |
|----|----------|---|
| 38 | 2PULSING | Puleggia guida cavo elettrico singola |
| 39 | 2PUL6018 | Puleggia guida cavo elettrico piccola |
| 40 | 2LAM.A51 | Lamiera posteriore |
| 41 | 2PULSEME | Pulsante a fungo emergenza |
| 42 | 2SELETT7 | Selettore a leva comando supplementare salita discesa |



ELEVAH65MOVE

| N° | Codice | Descrizione |
|----|-----------|---------------------------------|
| 43 | 2LAMPADE2 | Luce ingombro 24V |
| 44 | 2AVVOLGC | Avvolgicavo retrattile batterie |
| 45 | 2S.AVVOLG | Supporto avvolgicavo |
| 46 | 2CAVE718 | Cavo comando 18x1 |
| 12 | ZTAPPO | TAPPO Kit.car (vedi sopra) |
| 47 | 2MOLLGAS | Molla a gas suspa |

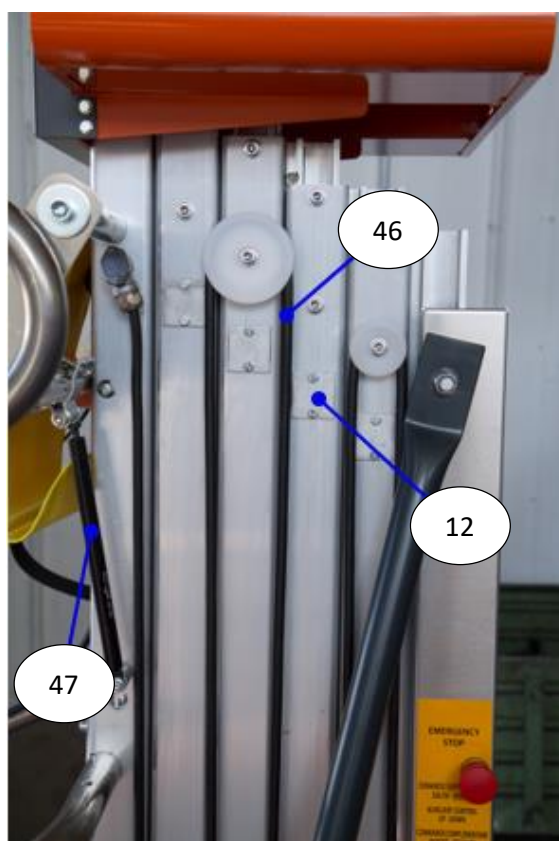

ELEVAH65MOVE

| N° | Codice | Descrizione |
|----|------------|-------------------------------|
| 48 | 2MICRO01 | Micro sicurezza TZ-7121 |
| 49 | 2MICRO06 | Micro sottocolonna |
| 50 | 2QUADRE9 | Modulo TS100 |
| 51 | 2CICAL64 | Cicalino buzzer intermittente |
| 52 | 2CICAL65 | Cicalino buzzer continuo |
| 53 | IMA-396.01 | Staffa buzzer |

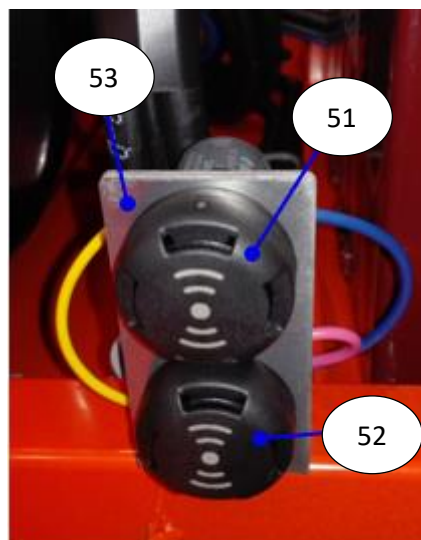
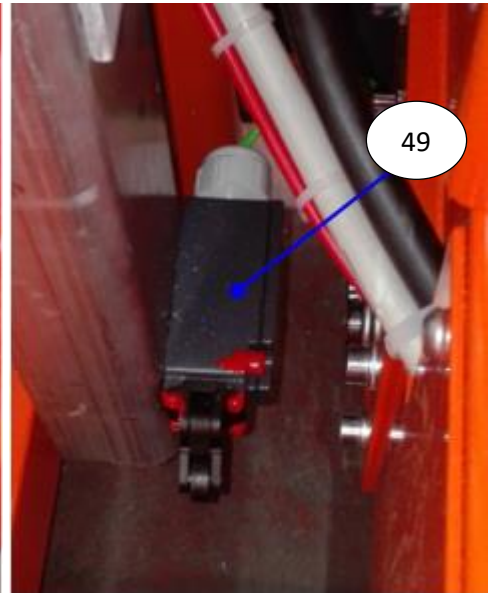
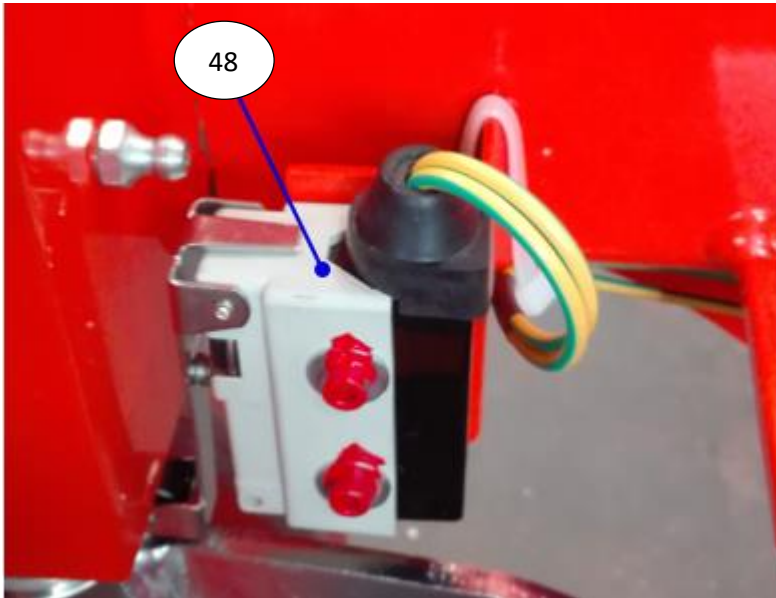

ELEVAH65MOVE

| N° | Codice | Descrizione |
|----|----------|--------------------------------|
| 54 | 2CAR.B18 | Caricabatterie S.P.E. 10A-24V |
| 55 | 2BASE.FU | Base fusibile |
| 56 | 2FUS.80A | Fusibile 80A |
| 57 | 2CONT104 | Teleruttore tipo elektrosistem |
| 58 | 2CLACSON | Clacson |

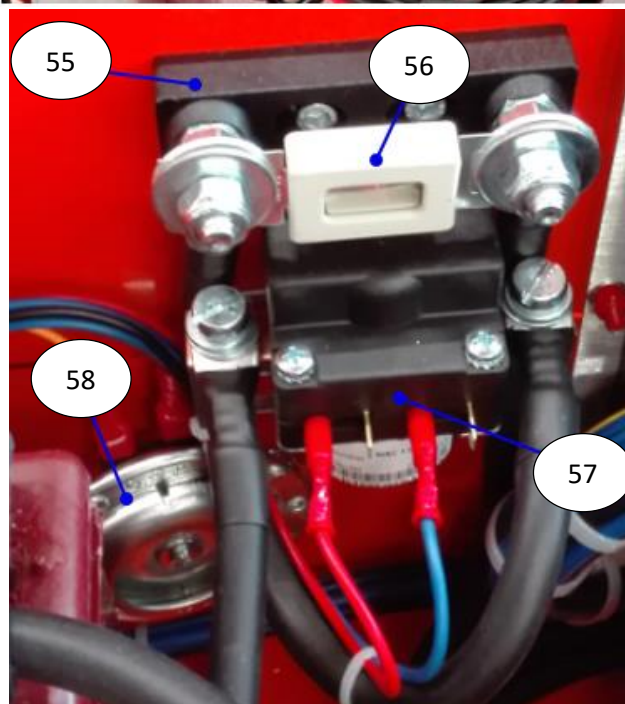

ELEVAH65MOVE

| N° | Codice | Descrizione |
|----|------------|--------------------------------------|
| 59 | IMA-458.08 | Coperchio comandi |
| 60 | IMA-458.01 | Piastra cestello |
| 61 | CESUP.32 | Cestello superiore |
| 62 | CEINF.32 | Cestello inferiore |
| 63 | ZTUBOC32 | Tubo collegamento cestello D30 MM675 |
| 64 | ZRIN.C31 | Piatto 4 fori attacco cestello |

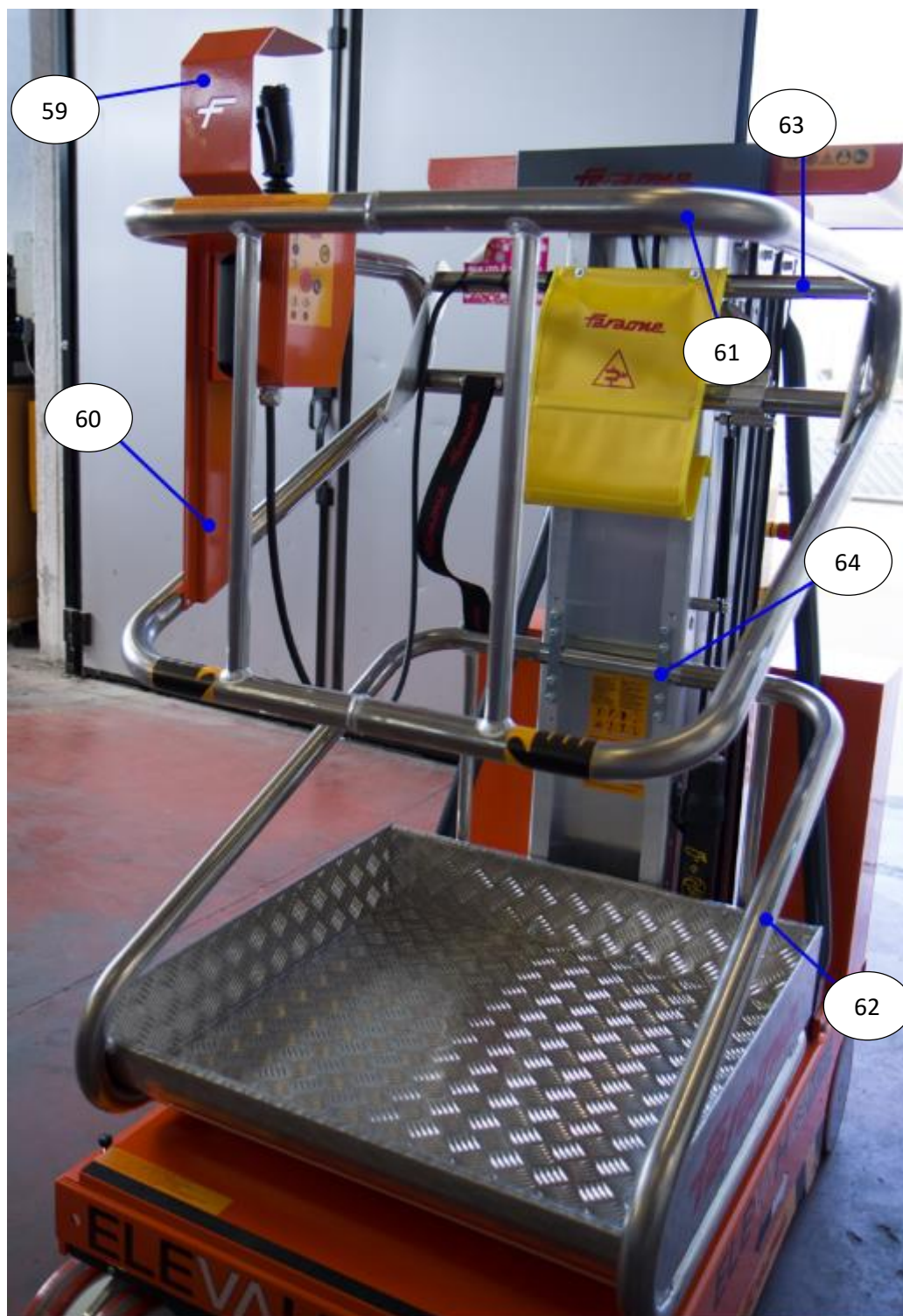

ELEVAH65MOVE

| N° | Codice | Descrizione |
|----|------------|--|
| 65 | IMA-458.02 | Supporto collegamento cestello-comandi |
| 66 | 2MANIGL6 | Maniglia |
| 67 | 2JOYSTIC7 | Joystick comandi |
| 68 | 2SUPCOMC | Supporto comandi |
| 69 | 2SELETT6 | Selettore a leva corta 2 posizioni |
| 70 | 2PULSEM4 | Pulsante ad impulso giallo |
| 71 | 2PULSEME | Pulsante emergenza fungo rosso |
| 72 | 2SELETT5 | Selettore a chiave 2 posizioni |
| 73 | 2POTENZ1 | Potenziometro 5k (su richiesta) |
| 74 | 2IND.BAT | Indicatore di batterie e contaore |
| 75 | 2SPIA.R2 | Spia rossa 24 v |
| 76 | 2MOLL.AR2 | Pistoncino con anello m.12 |
| 60 | IMA-458.01 | Piastra cestello (vedi sopra) |

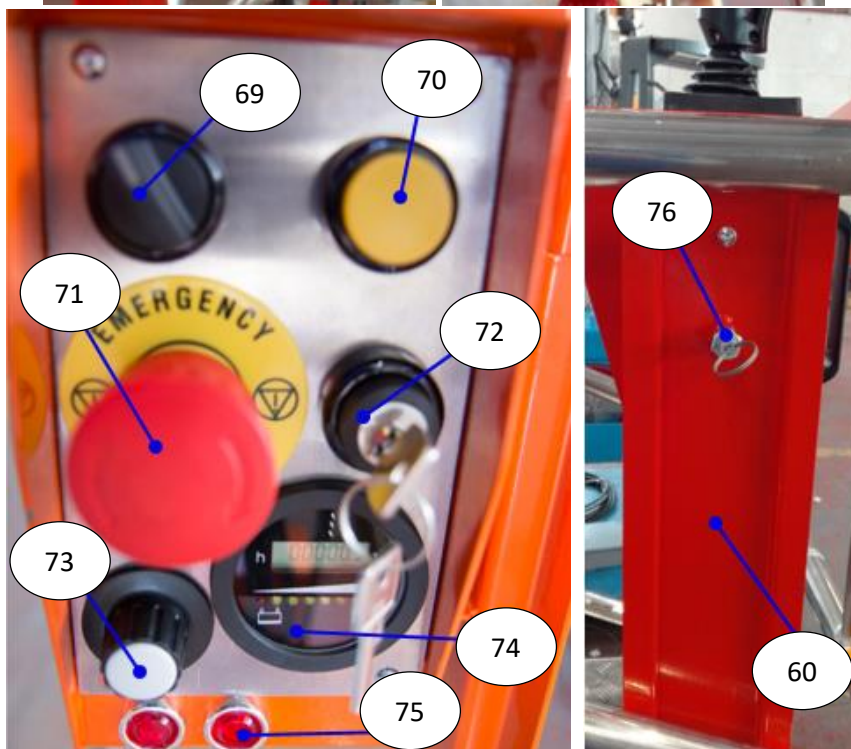
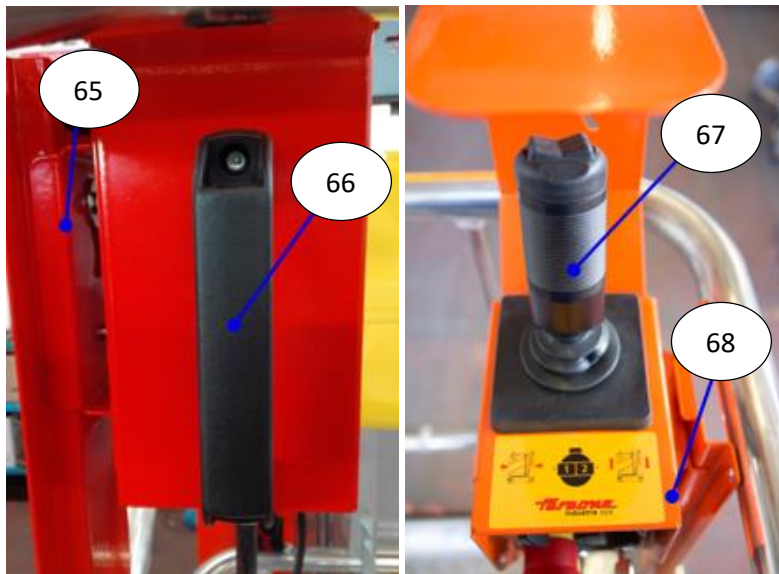

ELEVAH65MOVE

| N° | Codice | Descrizione |
|----|----------|-------------------------------|
| 77 | 2TELOPRO | Telo protezione gancio giallo |
| 78 | 2CINTA56 | Cinta faraone per cestello |
| 79 | 2TUBOEL | Tubo portadocumenti |



ELEVAH65MOVE

| N° | Codice | Descrizione |
|----|----------|---------------------------------------|
| 80 | 2MICRO06 | Micro finecorsa sollevamento cestello |
| 81 | 2GANCIO6 | Gancio blocco cestello |
| 82 | 2ANEL10C | Anello elastico |
| 83 | 2MOL1253 | Molla gancio blocco cestello |
| 84 | 2MOLLA18 | Molla albero blocco cestello |
| 85 | 2PRES135 | Pressacavo PG 13,5 |
| 86 | 2POMELM5 | Pomello |
| 87 | 2PERN258 | Albero gancio blocco cestello |
| 88 | 2BLOCCOC | Registro blocco |

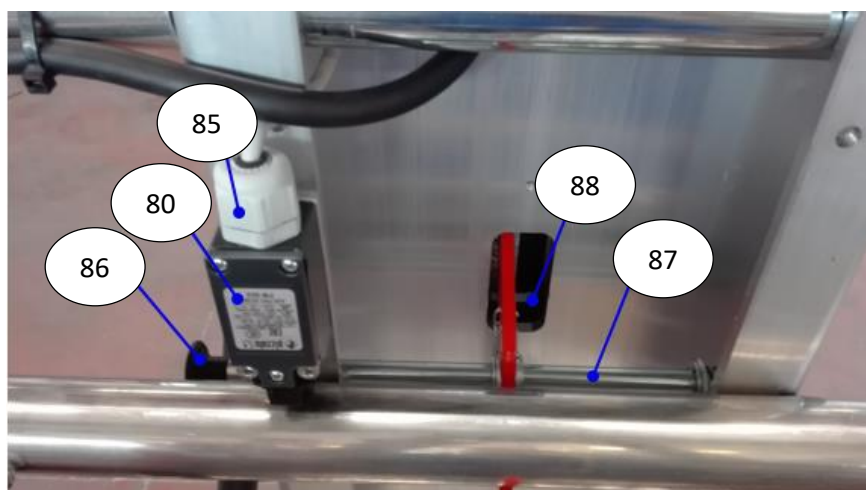
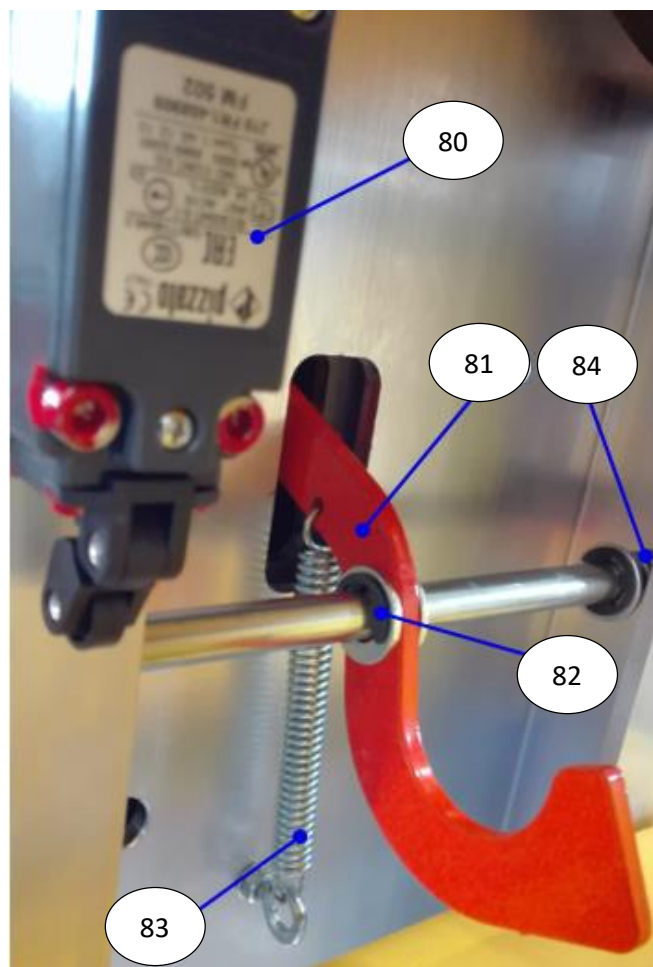

ELEVAH65MOVE

| N° | Codice | Descrizione |
|----|----------|--|
| 89 | 2CENTR27 | Centralina idraulica |
| 90 | 2BAT.85T | Batteria trojan in figura (a seconda della scelta) |
| 90 | 2BAT.31A | Batteria AGM (a seconda della scelta) |
| 91 | 2COPRI.M | Coprimorsetti di gomma per batterie |

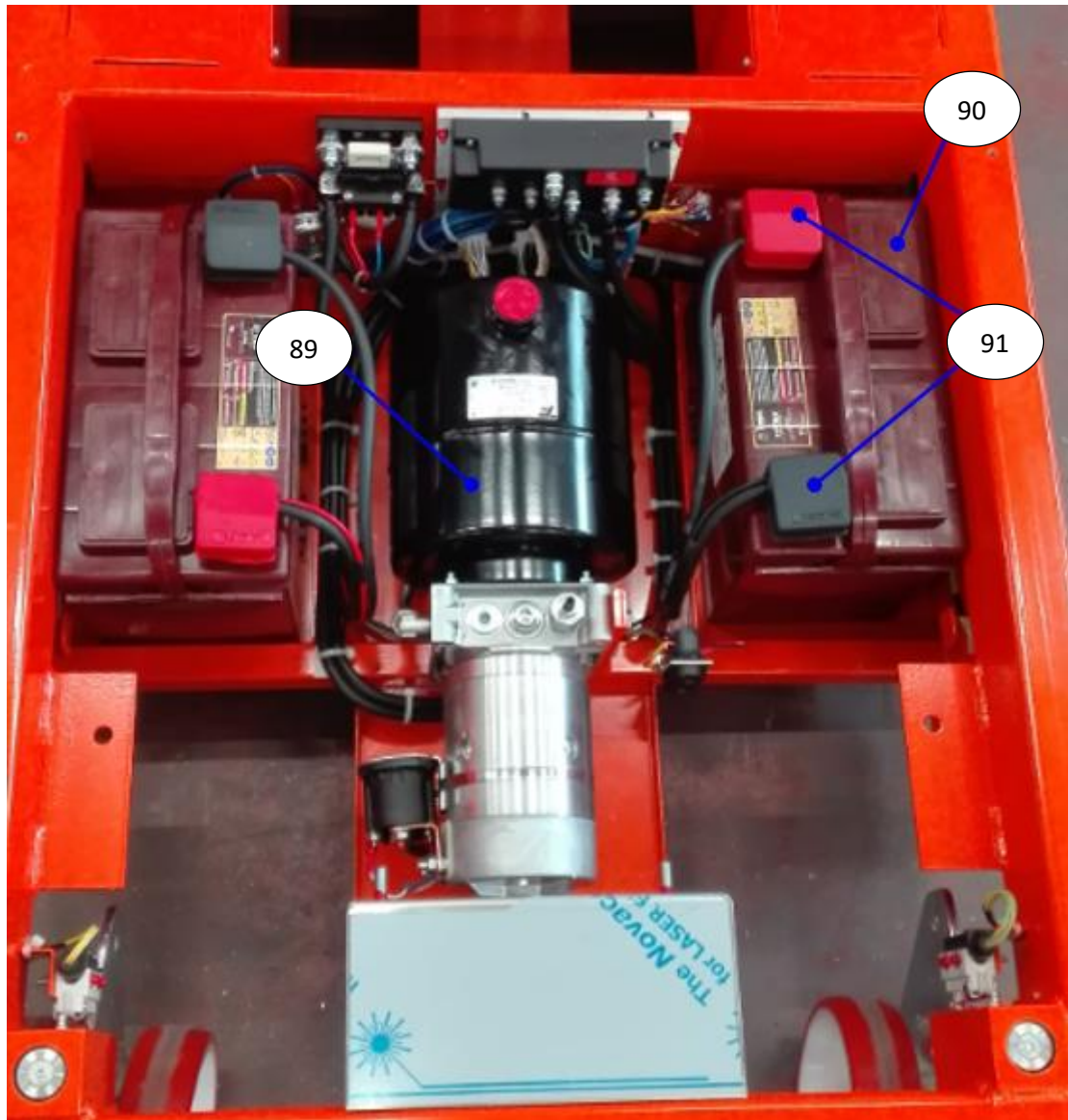

ELEVAH65MOVE

| N° | Codice | Descrizione |
|----|-----------|------------------------------|
| 92 | 2MOTOREP2 | Motore trazione |
| 93 | 2RIDUT63 | Riduttore trazione |
| 94 | 2R000005 | Rosetta di sicurezza MB5 |
| 95 | 2GHI2515 | Ghiera autobloccante M25X1,5 |

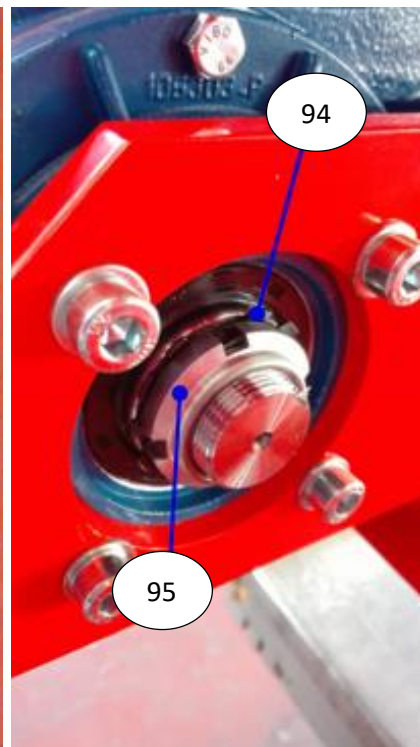

ELEVAH65MOVE

| N° | Codice | Descrizione |
|----|----------|------------------------|
| 96 | 2RUO200H | Ruota folle girevole |
| 97 | 2ROND35C | Rondella di bloccaggio |
| 98 | 2RUOPKS6 | Ruota trazione |

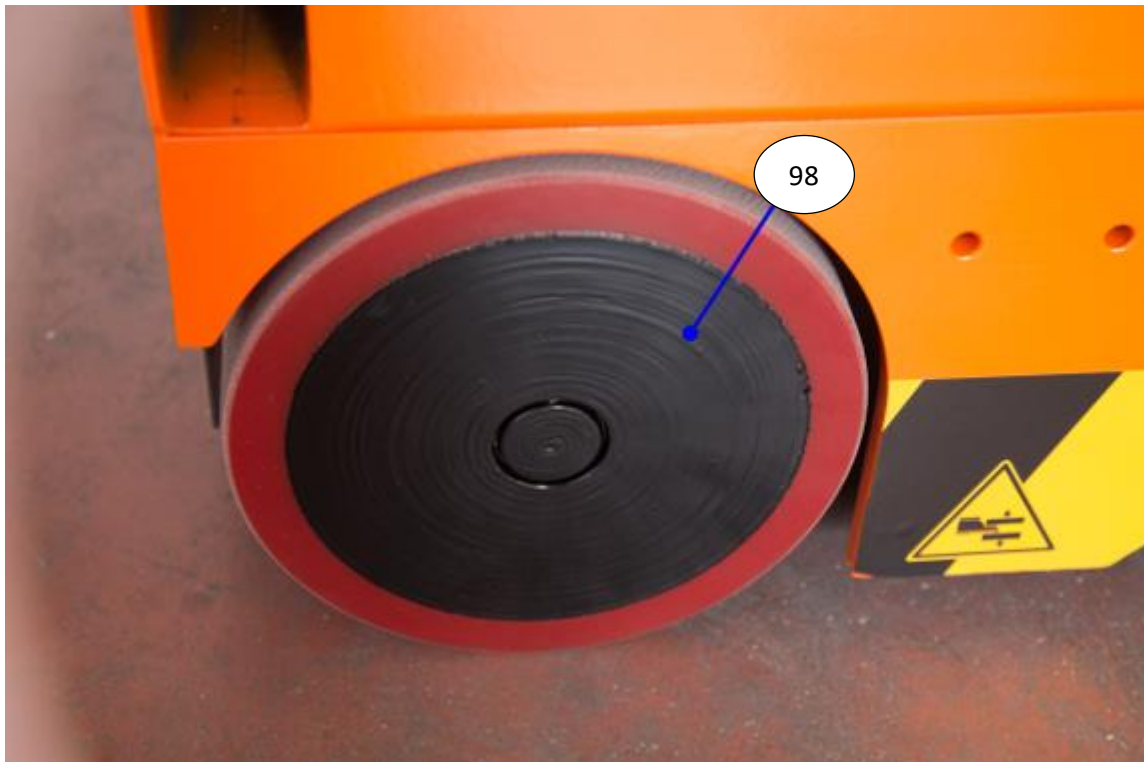
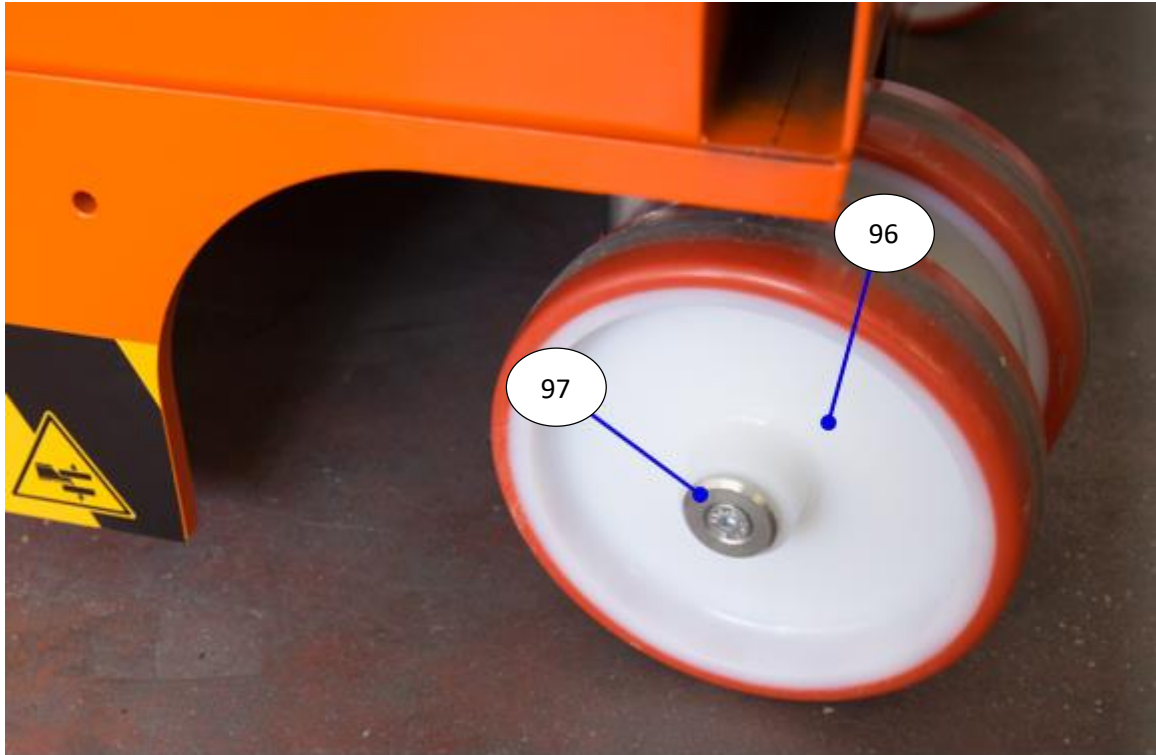

ELEVAH65MOVE

| N° | Codice | Descrizione |
|-----|-----------|---------------------------------------|
| 99 | 2RONDH30 | Rondella superiore |
| 100 | 2CUS1003 | Cuscinetto 61804 2RS |
| 101 | 2MOLLH65 | Molla interna |
| 102 | 2RONDH39 | Rondella guida |
| 103 | 2CUS1004 | Cuscinetto 51104 |
| 104 | 2ANELH65 | O-RING 3137 |
| 105 | 2SUPRUOT | Supporto ruota girevole |
| 48 | 2MICRO001 | Micro (vedere sopra) |
| 97 | 2ROND35C | Rondella di bloccaggio (vedere sopra) |
| 96 | 2RUO200H | Ruota folle (vedere sopra) |

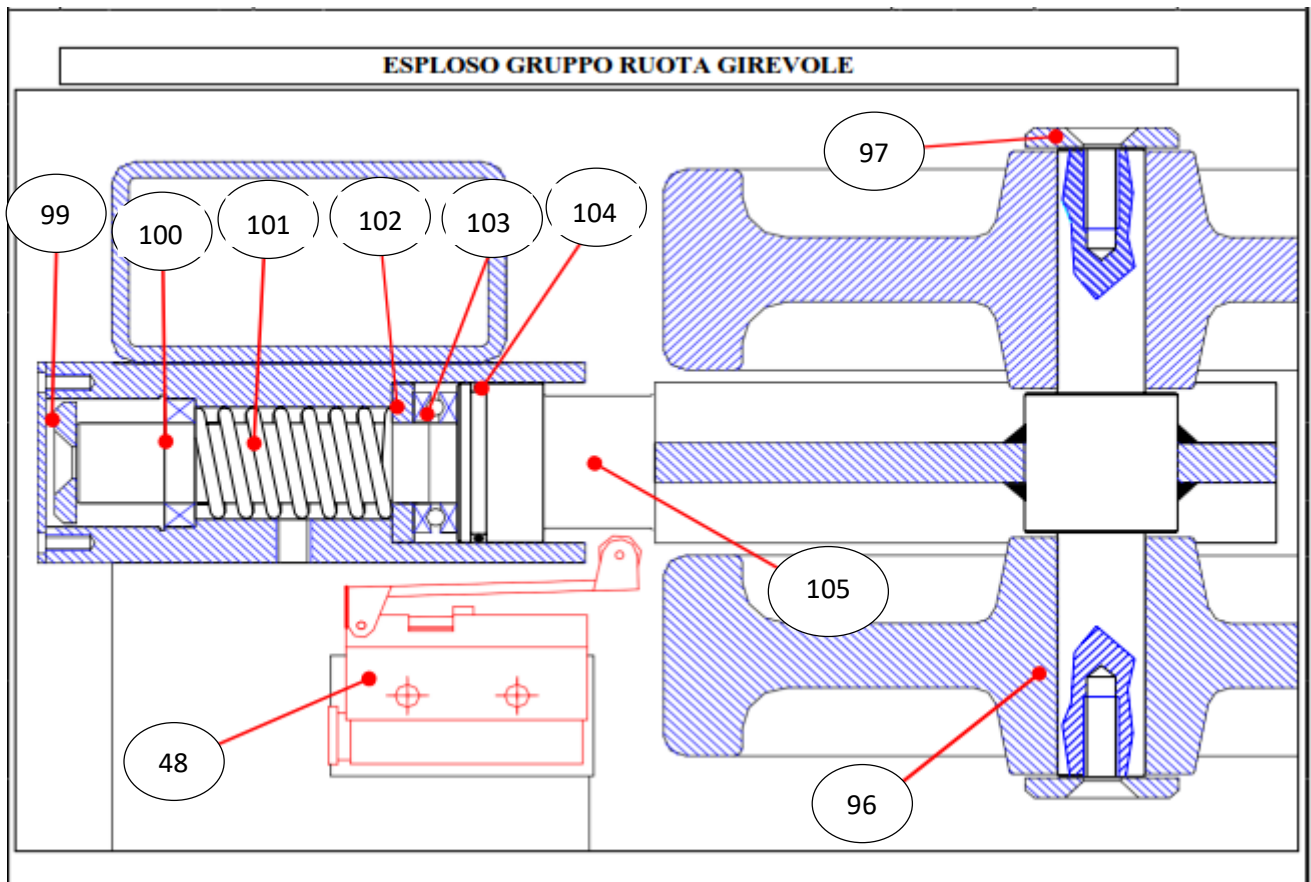

ELEVAH65MOVE

| N° | Codice | Descrizione |
|-----|----------|--|
| 106 | 2CHIAV02 | Chiavetta per albero ruota 50x8x7 |
| 107 | 2CHIAV03 | Chiavetta per albero riduttore 100x8x7 |
| 108 | 2DISTA40 | Distanziale |
| 109 | 2PERN241 | Perno |

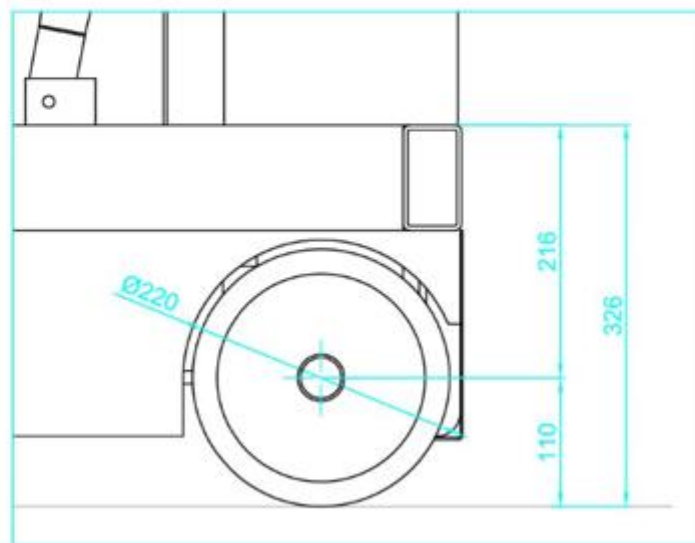
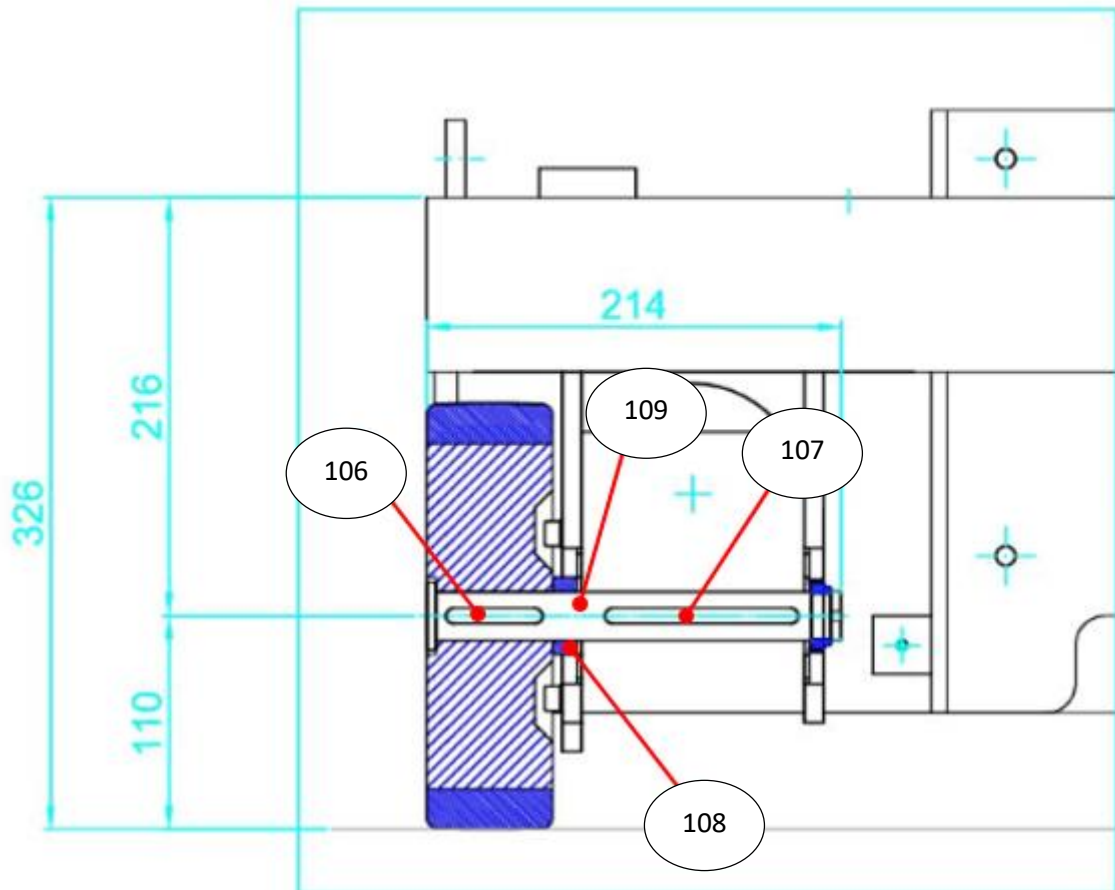

ELEVAH65MOVE

| N° | Codice | Descrizione |
|-----|------------|---------------------|
| 110 | IMA-458.09 | Piano sopra colonna |
| 111 | IMA-458.12 | Porta documenti |
| 112 | 2BARRA16 | Barra filettata M16 |
| 113 | 2BOCCALL | Boccola |
| 114 | 2DISTA01 | Distanziale |

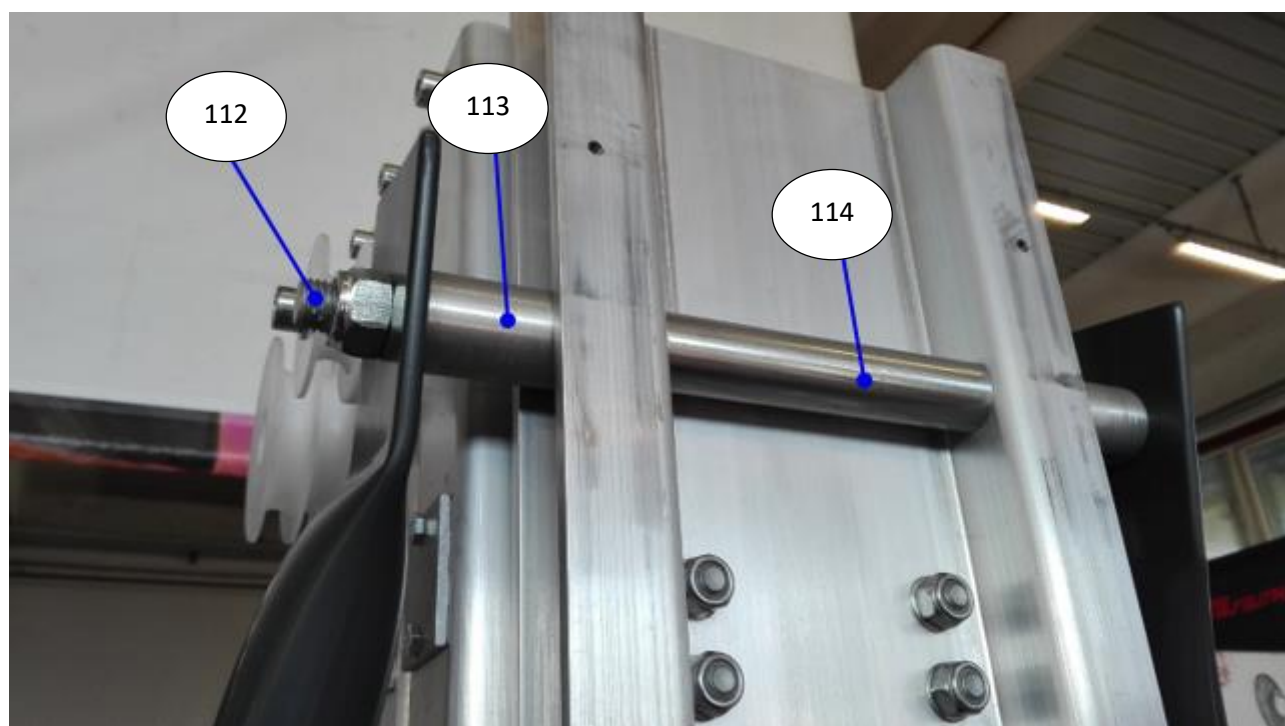

ELEVAH65MOVE

| N° | Codice | Descrizione |
|-----|----------|--------------------------------------|
| 115 | 2SCATFI2 | Scatola di derivazione |
| 116 | 2BASE.F2 | Base di fissaggio contatti elettrici |
| 117 | 2CONTNA2 | Unità di contatto normalmente aperto |
| 118 | 2CONTNC2 | Unità di contatto normalmente chiuso |

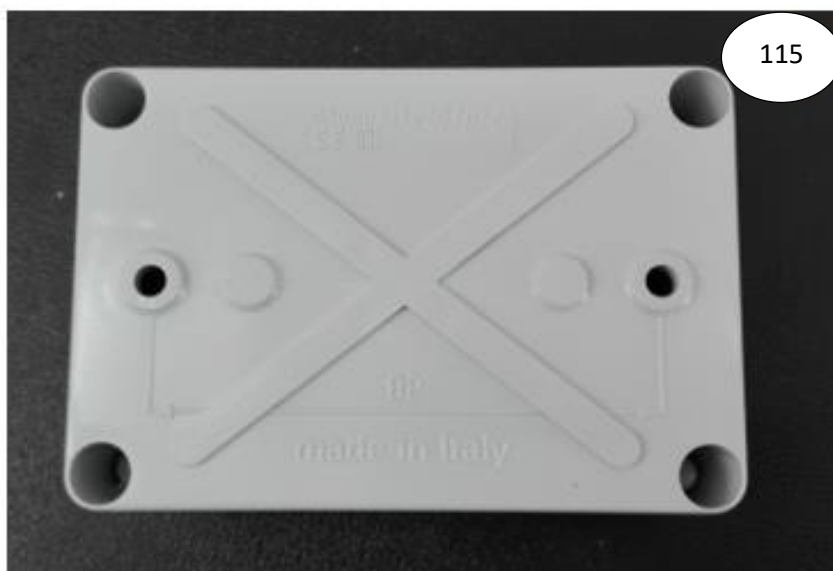

ELEVAH65MOVE

| N° | Codice | Descrizione |
|-----|------------|------------------------------------|
| 119 | 3TARGAM2 | Targa matricolare |
| 120 | 2MORSETB | Morsetto per collegamento batterie |
| 121 | 2BOCCZ19 | Boccola puleggia interna |
| 122 | IMA-436.01 | Allaccio cintura di sicurezza |



119



120

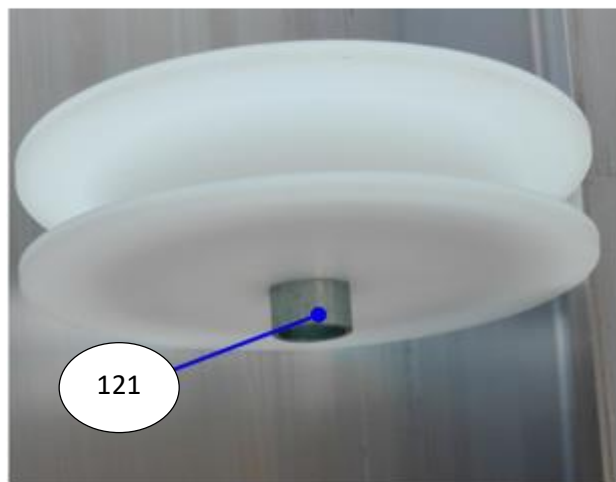

121



122

ELEVAH65MOVE

| N° | Codice | Descrizione |
|-----|----------|--------------------------|
| 123 | 2SPESPE1 | Spessore pettine singolo |
| 124 | 2BOC.PUL | Boccola puleggia catene |

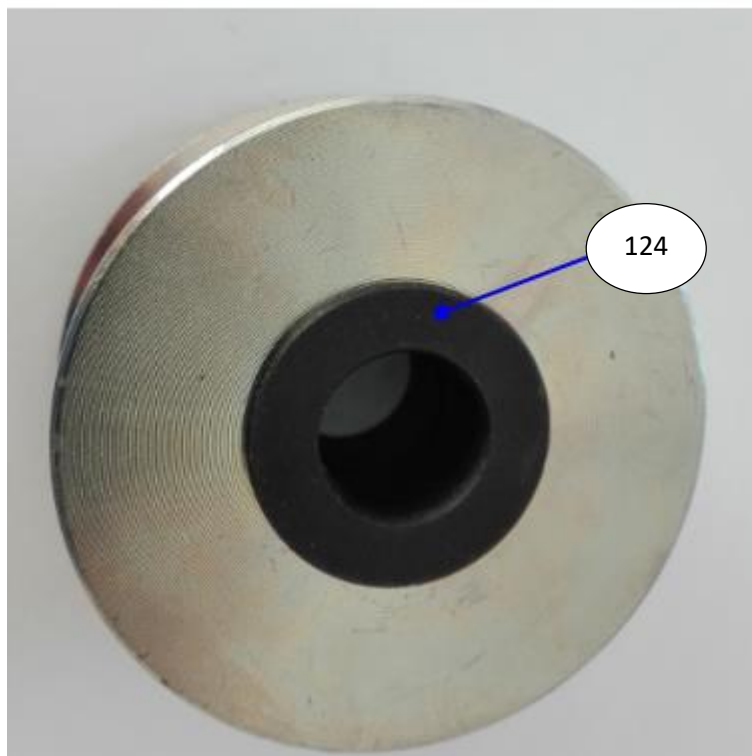

ELEVAH65MOVE

| N° | Codice | Descrizione |
|----|-----------|-----------------|
| 92 | 2MOTOREP2 | Motore trazione |



RICAMBI 2MOTOREP2

| Codice | Descrizione |
|------------|-------------------------------|
| 2FRENOE4 | Freno 2MOTOREP2 |
| 2SPAZZOLP2 | Spazzola motore per 2MOTOREP2 |

| ELEVAH65MOVE | | |
|---------------------|---------------|----------------------|
| N° | Codice | Descrizione |
| 89 | 2CENTR27 | Centralina idraulica |



| RICAMBI PER 2CENTR27 | | |
|-----------------------------|---------------|----------------------------|
| N° | Codice | Descrizione |
| 125 | 2MOT.C27 | Motore 2CENTR27 |
| 126 | 2SPAZZOL27 | Spazzole motore 2CENTR27 |
| 127 | 2POMPA27 | Pompa 2CENTR27 |
| 128 | 2FILTRO27 | Filtro 2CENTR27 |
| 129 | 2VLV.EME3 | Valvola emergenza 2CENTR27 |

