

*AERIAL PLATFORM*  
*ELEVAH 70*

USE AND MAINTENANCE INSTRUCTIONS

Translation of the original instructions



**SECTION 0. INTRODUCTION**

**INDEX**

SECTION 0. INTRODUCTION.....	0-1
INDEX.....	0-1
INTRODUCTION.....	0-2
SYMBOLS AND TERMS.....	0-2
TECHNICAL ASSISTANCE - WARRANTY.....	0-3
NOTICES.....	0-3
SECTION 1. SAFETY PRECAUTIONS.....	1-1
GENERAL INFORMATION.....	1-1
PRELIMINARY PROCEDURES.....	1-2
OPERATION.....	1-3
SECTION 2. GENERAL TECHNICAL DATA.....	2-1
BASIC CONSTRUCTIVE DATA.....	2-3
SECTION 3. PREPARATION AND INSPECTION.....	3-1
PERSONNEL TRAINING.....	3-1
FUNCTIONAL TEST.....	3-2
SAFETY WARNINGS FOR THE OPERATORS.....	3-3
SECTION 4. CONTROLS, LIGHTS AND MACHINE OPERATION.....	4-1
INTRODUCTION.....	4-1
MACHINE OPERATION.....	4-1
24 V BATTERY POWER SUPPLY.....	4-2
220 V POWER SUPPLY.....	4-3
GROUND CONTROL STATION.....	4-4
PLATFORM CONTROL CONSOLE.....	4-6
POSITIONS OF THE BASKET ASSEMBLY.....	4-8
PARKING THE MACHINE.....	4-10
TRANSPORT AND LIFTING PROCEDURES.....	4-11
SECTION 5. EMERGENCY PROCEDURES.....	5-1
EMERGENCY OPERATION.....	5-1
REPORTING THE ACCIDENT.....	5-2
SECTION 6. DAILY INSPECTION.....	6-1
SECTION 7. ROUTINE MAINTENANCE.....	7-1
MAINTENANCE EVERY THREE MONTHS.....	7-2
MAINTENANCE EVERY SIX MONTHS.....	7-3
MAINTENANCE EVERY TWO YEARS.....	7-3
SECTION 8. MAINTENANCE OPERATING INSTRUCTIONS.....	8-1
BATTERY MAINTENANCE.....	8-1
HYDRAULIC OIL CHANGE.....	8-2
CHECKS ON LIFTING CHAINS.....	8-3
SECTION 9. ATTACHED DOCUMENTATION.....	9-1
ATTACHMENT 1 – Layout for the application of the stickers.....	9-1
ATTACHMENT 2 – version 24 V hydraulic diagram.....	9-3
ATTACHMENT 3 – Version 220 V hydraulic diagram.....	9-4
ATTACHMENT 4 – Version 24 V Wiring diagram.....	9-5
ATTACHMENT 5 – Version 220 V wiring diagram.....	9-6
ATTACHMENT 6 - Inspection certificate.....	9-7
ATTACHMENT 5 – Declaration of conformity.....	9-8
SECTION 10. MAINTENANCE LOGBOOK.....	10-1

**ENGLISH****INTRODUCTION**

The purpose of this use and maintenance manual is to supply the users with the essential information for carrying out the procedures for safe and correct operation of the machine, for the purposes for which the same has been manufactured.

All information contained in this manual must be read and understood before making any attempt to operate the machine.

**THIS MANUAL IS A VERY IMPORTANT DOCUMENT; ALWAYS KEEP IT NEAR THE MACHINE.**

Due to continuous improvements to the products, Faraone Industrie Spa reserves the right to amend the technical data without any prior notice. For updated information, contact Faraone Industrie Spa.

**ATTENTION**

**REMEMBER NO EQUIPMENT IS SAFE IF THE OPERATOR DOES NOT OBSERVE THE SAFETY PRECAUTIONS**

**SYMBOLS AND TERMS****ATTENTION**

The danger symbol recalls the attention to potential dangers that might cause injuries. To avoid possible injuries or fatal accidents, comply with all safety instructions that follow the symbol.



Arrows are used in the pictures of the machine to indicate the specific points described in the text of the manual.

- **Aerial Platform:** A machine intended to move persons to their work position, where they carry out their tasks from the work platform.
- **Work platform (basket):** A platform or cage that is moved to the required work position when loaded and from which the operator can carry out construction, repairs, inspections, or other similar operations.
- **Stabilisers:** Devices used to stabilise the mobile work aerial platform, supporting and levelling it in its entirety.
- **Extending structure:** A structure connected to the frame that supports the work platform and enables movement from the platform to the required work position.
- **Frame:** Machine Base. It can be a pushed or self-propelled type.
- **Nominal load:** A load which the aerial work cage has been designed for to operate regularly and which consists of people, tools and material.

**TECHNICAL ASSISTANCE - WARRANTY**

The Client must make sure to have the serial number of the machine and an accurate description of the problem or of the information to be provided before contacting the Manufacturer.

**The warranty period is 12 months from the date of the purchase invoice.**

Said warranty covers faulty components and the labour required for servicing, if this is carried out at the Manufacturer's premises (the transport of the machine is borne by the purchaser).

**The warranty is valid provided all rules laid down for correct use of the machine are complied with.**

**The machine is designed and built to last years, as long as it is always used for the purposes it is intended for and that the inspections and maintenance described herein are carried out.**

**Faraone Industrie Spa deems it necessary to conduct an extensive analysis of all of the structural components every 10 (ten) years, to confirm their integrity.**

**NOTICES**

For machines sold in Italy:

According to art. 71, paragraph 11 of the (Italian) Legislative Decree 81/2008, the employer/owner of the machine platform is obliged to report commissioning of the same to the local department of INAIL (National Institute for the Prevention of Accidents at Work).

He must also arrange for the machine to be given an ANNUAL inspection of its condition and working order.

For machines sold in other countries:

The owner of the machine must decide whether to report installation of the machine and/or assess the need for periodic inspections by specific relevant entities.

**SECTION 1. SAFETY PRECAUTIONS****GENERAL INFORMATION**

This section illustrates the necessary precautions for the correct and safe use and for machine maintenance. To guarantee correct use of the machine, it is essential to establish a daily routine procedure based on the instructions provided in the manual. Also, to guarantee safe operation of the machine, it is necessary for a qualified person to establish a maintenance programme based on the information provided in this manual; such programme must be scrupulously followed.

The owner/user/operator/company granting in leasing/person receiving in leasing the machine, must not accept responsibility of its operation before having carefully read the manual and completed the training and the functioning procedures, guided by an experienced and qualified operator.

For further information relating to safety, training, inspection, maintenance, application and operation, contact Faraone Industrie Spa.

**ATTENTION**

**THE NON COMPLIANCE WITH THE SAFETY PRECAUTIONS LISTED IN THE MANUAL MAY CAUSE DAMAGES TO THE MACHINE AND TO THE PROPERTY AND INJURIES OR FATAL ACCIDENTS.**

## PRELIMINARY PROCEDURES

### Operator training and know-how

- Carefully read the manual before using the machine.



- Use the machine only after complete training by authorised personnel.
- The use of the machine is allowed exclusively to authorised and qualified personnel.
- Read carefully and follow all the WARNING statements and the operational instructions reported on the machine and in the manual.
- Use the machine for the applications falling within those envisioned by Faraone Industrie Spa.
- All operational personnel must familiarize with the emergency operations and controls of the machine, as specified in the manual.
- Carefully read and comply with all company, local and government Standards in force, relating to machine operation.

### Inspection of the work place

- Before using the machine, the operator must take the necessary precautions to avoid any danger in the work place.
- Do not activate the machine on lorries, trailers, railway wagons, boats, scaffolding or similar, unless Faraone Industrie Spa has approved the operation in writing.
- The machine can be switched on at temperatures between -15°C and 40°C. Contact Faraone Industrie for values relating to machine operation at temperatures not within the indicated range.
- The machine cannot be started in environments declared ATEX, unless specifically indicated in the EC certificate of conformity delivered with the machine in question.

### Machine inspection

- Use the machine only after having carried out the functional verifications and inspections. For further instructions, consult *Section 3* of this manual.
- Activate the machine only after having carried out all assistance and maintenance interventions envisioned by the requirements specified in this manual.
- Make sure all safety devices work properly. Any amendments to such devices constitute violation of the safety Standards.
- Do not activate the machine whose signs or adhesives indicating the safety Standards or instructions are illegible or missing.
- Avoid the accumulation of debris on the floor of the machine. Avoid mud, oil, grease and other slippery substances coming into contact with shoes and with the floor of the machine.



### **ATTENTION**

**ANY AMENDMENTS OR ALTERATIONS TO THE MACHINE MAY ONLY BE APPLIED EXCLUSIVELY WITH PRIOR WRITTEN AUTHORISATION FROM THE PRODUCER.**

**OPERATION**

**General information**

- Only use the machine to lift personnel with the relative tools and equipment.
- Do not activate a faulty machine. If a fault occurs, switch-off the machine.
- Do not suddenly move the control switches or levers from one position to the opposite one, going via the neutral position; always bring the switch to neutral position before moving it in the position corresponding to the next function. Activate the controls by applying slow and even pressure.
- If there are people on the work platform, enable personnel to activate the machine from the ground exclusively in the event of an emergency.
- Completely lower the extending structure and disconnect the power supply before moving away from the machine.
- When welding is carried out with the machine, take precautions to protect all machine components from contact with sprays generated from welding or with the melted metal.
- Ensure that the electric tools are put back correctly, avoiding leaving them hanging on the cables in the work area of the platform.
- (In case of a battery powered machine) Charge batteries in a well-ventilated area.

**Risk of falls**



- Before using the machine, ensure all rails and gates are fixed in the correct position.
- Keep both feet firmly on the floor of the work platform. Do not arrange ladders, boxes, steps, planks or similar items on the platform to increase the range of action.
- Do not use the extension unit to climb on or off the platform.
- Pay maximum attention when entering or coming out of the platform. Ensure the extending structure is completely lowered. Face the machine when entering or coming out of the platform. Always maintain "three contact points" with the machine, ensuring both hands and one foot or one hand and both feet are continuously in contact with the machine when entering and exiting.

**Danger of electrocution**



With regard to the safety distances from live parts of power lines and electrical systems that are not protected or not sufficiently protected to be complied with when carrying out non-electric jobs, at net clearance deriving from the type of job, the equipment used and the materials handled, as well as the lateral shifting of the conductors owing to the action of wind and lowering of heights due to heat conditions, refer to the Laws regarding safety in the workplaces of the country where the machine is operating.

For Italy, refer to Legislative Decree 81/08, annex IX "Values of rated operating voltages of electrical machines and systems".

**Danger of overturning**

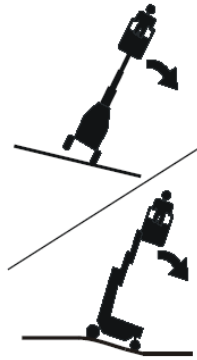

- Do not lift the work platform on a slope or on irregular or soft surfaces.
- Before driving the machine on floors, bridges, lorries and other surfaces, check their maximum capacity values.
- Do not exceed the maximum capacity of the machine. Evenly distribute the loads on the floor of the work platform as best as possible.
- Keep the machine chassis (including stabilisers) at a minimum distance of 0.5 m from holes, unevenness, descents, obstacles, debris, hidden holes and other potential dangers found at ground level.
- Do not attempt to use the machine as a crane. Do not tie the machine to an adjacent structure.
- Do not increase the dimension of the working platform with unauthorised extensions or by extending the platform.
- If the extending structure or the work platform remains jammed so that one or more wheels are lifted from the ground, the operator is required to climb off the working platform before attempting to free the machine. To stabilise the machine and have personnel climb down from the work platform, use a crane, forklift trucks or other adequate equipment.
- Do not move the machine with the stabilisers inserted and the extendible structure lifted. Before moving the machine, completely lower the extendible structure.

**Danger of crushing and impact**



- When using the machine or lifting or lowering the work platform, check the distances above, at the sides and below the said platform.
- Do not lean out of the rails of the work platform when the machine is running.
- Always pay maximum attention to avoid any obstacles from hitting the operational controls and people on the work platform or from interfering with them.
- Make sure the operators of other machines, overhead or at ground level, are informed of the presence of the machine.
- Warn personnel not to work, stand or transit underneath the lifted platform. Mark off the floor area with appropriate barriers, as required.



### **Towing, lifting and carrying**

- Do not allow personnel to stand on the work platform while towing, lifting and carrying.
- Tow the machine exclusively in case of emergency, fault, power supply cut-off or to load/unload it. Consult the "Emergency procedures" section in this manual.
- Before towing, lifting and carrying, make sure that the working platform is completely retracted and emptied.
- Do not pull or push a blocked or disabled machine.
- While lifting the machine by means of a forklift, arrange the latter exclusively in correspondence of the appropriate areas of the same machine. Lift by means of a lifting device with adequate capacity.

For information regarding lifting, refer to the relative section in the manual.

**SECTION 2. GENERAL TECHNICAL DATA****ATTENTION**

**THE AERIAL PLATFORM ELEVAH 70 IS A LIFTING MACHINE INTENDED TO MOVE PERSONS TO THEIR WORK POSITIONS, FROM WHERE THEY ARE TO CARRY OUT THEIR TASKS FROM THE WORK PLATFORM.**

**THE AERIAL PLATFORM ELEVAH 70 MUST BE USED ONLY FOR THE PURPOSES FOR WHICH IT WAS CONCEIVED.**

**ANY OTHER USE IS CONSIDERED IMPROPER.**

**ATTENTION**

**THE USER MUST OBTAIN APPROVAL AND GUIDELINES FROM THE MANUFACTURER ON SPECIAL OPERATING METHODS OR CONDITIONS NOT COVERED IN THOSE SPECIFIED BY THE MANUFACTURER.**

GENERAL TECHNICAL DATA	Value
<b>Weight of the machine:</b> (Overall) <ul style="list-style-type: none"> <li>• Standard Power Supply</li> <li>• Optional Power Supply</li> </ul>	430 kg 400 kg
<b>Stabiliser weight:</b>	5 kg
<b>Machine height:</b> (in transport position)	170 cm
<b>Maximum resting pressure on ground:</b> per wheel/stabiliser (*) <ul style="list-style-type: none"> <li>• Standard Power Supply</li> <li>• Optional Power Supply</li> </ul>	215 daN 200 daN
<b>Maximum passable slope:</b> (in transport position)	15% - 9°
<b>Maximum longitudinal work slope:</b>	Base "LEVEL"
<b>Maximum transversal work slope:</b>	Base "LEVEL"
<b>Machine base with stabilisers:</b> (length x width)	138 cm x 135 cm
<b>Machine base without stabilisers:</b> (length x width)	128 cm x 78 cm
<b>Manual maximum horizontal side force:</b>	200 N
<b>Maximum hydraulic plant pressure:</b>	70 bar
<b>Capacity of the hydraulic tank:</b>	~ 5 Litres
<b>Power supply</b> <ul style="list-style-type: none"> <li>• Standard</li> <li>• Optional</li> </ul>	2 12V 100 Ah batteries 220 V 50/60 Hz
<b>Operators inside the work platform:</b>	1
<b>Maximum capacity in the work platform:</b>	200 kg
<b>Internal dimensions of the work platform:</b>	79 cm x 72 cm
<b>Permitted use</b>	INTERNAL
<b>Max capacity on the work surface:</b>	20 kg
<b>Maximum basket height:</b> (from the ground to the floor of the basket) <ul style="list-style-type: none"> <li>• Use without stabilisers STANDARD position HIGH position</li> <li>• Use with stabilisers STANDARD position HIGH position</li> </ul>	3.41 m 4 m 4.66 m 5.25 m
<b>Max speed for the work platform lifting:</b>	< 0,4 m/s
<b>Max speed for the work platform descent:</b>	< 0,4 m/s

**Table NOTE:**

\* : Maximum pressure of the stabiliser considering the weight of the platform plus the maximum load on the cage are fully distributed on only one side of the platform (fully asymmetrical load)

**BASIC CONSTRUCTIVE DATA**

**MACHINE FRAME:** The frame of the machine (called base) is built completely with galvanised iron profiles with rectangular section. All essential components are installed on the frame for normal machine operation in stable conditions.

**EXTENDING STRUCTURE:** The extending structure is made of special extruded aluminium alloy profiles that slide along each other on sliding blocks with nylon wheels. The kinematic connection between profiles is realized by chains.

A fluid power cylinder is installed between the first and second profile that, powered by the hydraulic control unit, enables to lift the structure. The chains connect the extendible structure elements to each other so that these can simultaneously lift.

**WORK PLATFORM:** The work platform is completely made of extruded aluminium profiles. The base floor is made of an aluminium sheet coated with a non-slip protection.

**EXPOSURE TO VIBRATIONS:** The machine does not produce vibrations such as to endanger the health of the operators. The weighted acceleration to which the entire body is subjected is less than  $0.5 \text{ m/s}^2$

**ACOUSTIC EMISSIONS:** The A-weighted emission sound pressure level is below 70dB

**ATTENTION**

**THE AERIAL PLATFORM ELEVAH 70 HAS BEEN TESTED BY THE MANUFACTURER THROUGH:**

- **STATIC STABILITY TESTS;**
- **OVERLOAD TESTS;**
- **OPERATION TESTS.**

## SECTION 3. PREPARATION AND INSPECTION

### PERSONNEL TRAINING

The machine is a transport device for personnel; therefore, it must be used and submitted to maintenance exclusively by trained personnel.

The machine cannot be used by persons under the influence of alcohol or drugs or subject to epileptic attacks, dizziness or loss of physical control.

#### Operator training

Operator training must include the following:

1. Use and limits of the platform and emergency controls, on the ground, and of the safety systems;
2. Signs/labels for controls, instructions and warnings on the machine;
3. Regulations defined by the employer and government standards;
4. Use of the approved protective device against falls (if required);
5. Knowledge of the mechanical operation of the machine sufficient to enable recognising of a fault;
6. Safe methods for using the machine in presence of overhead obstacles, other moving equipment and obstacles, depressions, holes and descents;
7. Methods to avoid dangers due to unprotected electric conductors;
8. Requisites of a particular work or particular application of the machine.

#### Training supervision

Training must be carried out under the supervision of a qualified person, in an open space and free from obstacles and must continue until the trainee is able to safely activate and use the machine.

#### Operator responsibility

The operator must be trained with regard to responsibility and authority to switch-off the machine in case of fault or in presence of other unsafe conditions, both relating to the machine and to the work area.

**NOTE:** *the owner shall provide qualified personnel for training both at the time of delivery of the first units and later, if requested by the user or by personnel.*

**FUNCTIONAL TEST**

At the end of the "DAILY INSPECTION" (section n°6), carry out a functional test of all plants in an area free from overhead obstacles and at ground level.

**ATTENTION**

**IF THE MACHINE DOES NOT WORK PROPERLY, SWITCH IT OFF IMMEDIATELY. WARN MAINTENANCE PERSONNEL OF THE PROBLEM. DO NOT USE THE MACHINE UNTIL IT IS DECLARED SAFE TO USE.**

Carry out a functional test as detailed below.

- 1. Carry out the operations as instructed, from the ground controls, without any load in the cage.**
  - a. Ensure all machine functions are disabled when activating (pressing) the emergency stop button;
  - b. Check the correct operation of the manual descent valve.
- 2. From the control console of the cage, carry out the detailed operations.**
  - a. Ensure the control console is correctly assembled and securely fastened;
  - b. Lift and lower the work platform checking that lifting and lowering happen regularly;
  - c. Ensure all machine functions are disabled when activating (pressing) the emergency stop button.

**SAFETY WARNINGS FOR THE OPERATORS**

Do not install and use the machine in the following cases:



**OUTDOORS AND IN THE PRESENCE OF WIND UNLESS THE MACHINE HAS BEEN  
DESIGNED FOR OUTDOOR USE**

**(DANGER OF STABILITY LOSS AND OVERTURNING)**



**CLOSE TO AERIAL OBSTACLES (power lines, protrusions, etc.)**

**(RISK OF ELECTROCUTION AND IMPACT)**



**WITH EXCESSIVE LOADS COMPARED TO LIMITS ALLOWED**

**(DANGER OF LOSS OF STABILITY AND OVERTURNING)**



**ON FLOORING WITH STRENGTH LOWER THAN THE WEIGHT OF THE MACHINE**

**(DANGER OF LOSS OF STABILITY AND OVERTURNING)**



**IN ALL CIRCUMSTANCES NOT SPECIFICALLY INDICATED UNDER OPERATING  
CONDITIONS IN THIS MANUAL**

**(GENERAL DANGER)**



**ATTENTION**

**THE ELECTRICAL SYSTEM OF THE MACHINE IS NOT IN ANTI-EXPLOSIVE EXECUTION (NO  
ATEX): THEREFORE YOU SHOULD CAREFULLY AVOID ITS USE IN AREAS SUBJECT TO  
ATEX RISK.**

**During the moving phase (on the ground):**

- ✓ Cautiously move the machine avoiding sudden manoeuvres;
- ✓ **DO NOT TRANSPORT PERSONS on the base frame of the machine and in any other position except for in the work position inside the platform;**
- ✓ Check the structural condition and cleanliness of the surfaces on which the machine is used (verify the surface is suitable for the weight of the machine in work conditions).

**During the ascent and descent phase:**

- ✓ Observe the maximum admissible capacity weights for the work platform;
- ✓ Ascertain overhead obstacles are not present along the trajectory, in vertical;
- ✓ Do not induce dangerous vibrations and/or oscillations such to entail stability loss of the machine and cause an eventual overturning.



**ATTENTION**

**THE MACHINE IS WITHOUT AN AUTOMATIC BASE LEVELLING VERIFICATION SYSTEM. BEFORE PROCEEDING WITH THE ASCENT/DESCENT PHASE, VERIFY CORRECT INCLINATION OF THE BASE BY VISUALLY CHECKING THE SPIRIT LEVELS. THE SPIRIT LEVELS MUST BE CENTRAL COMPARED TO THE INDICATOR, WITHIN THE TOLERANCE LIMITS.**



**ATTENTION**

**INSTALL THE STABILISING FEET IN ORDER TO REACH THE MACHINE'S MAXIMUM WORKING HEIGHT  
INSERT THE STABILISERS INTO THE APPROPRIATE SEATS (UNTIL THEY STOP) AND BLOCK THEM BY INSERTING THE SUPPLIED SAFETY PIN.  
LEVEL THE BASE BY ADJUSTING THE STABILISER'S FEET. PAY THE UTMOST ATTENTION WHEN SLIGHTLY LIFTING THE MACHINE'S WHEELS SO THAT THEY ONLY REST ON THE STABILISER'S FEET.**

**INSERTION AND LOCKING OF 4 STABILISER FEET**

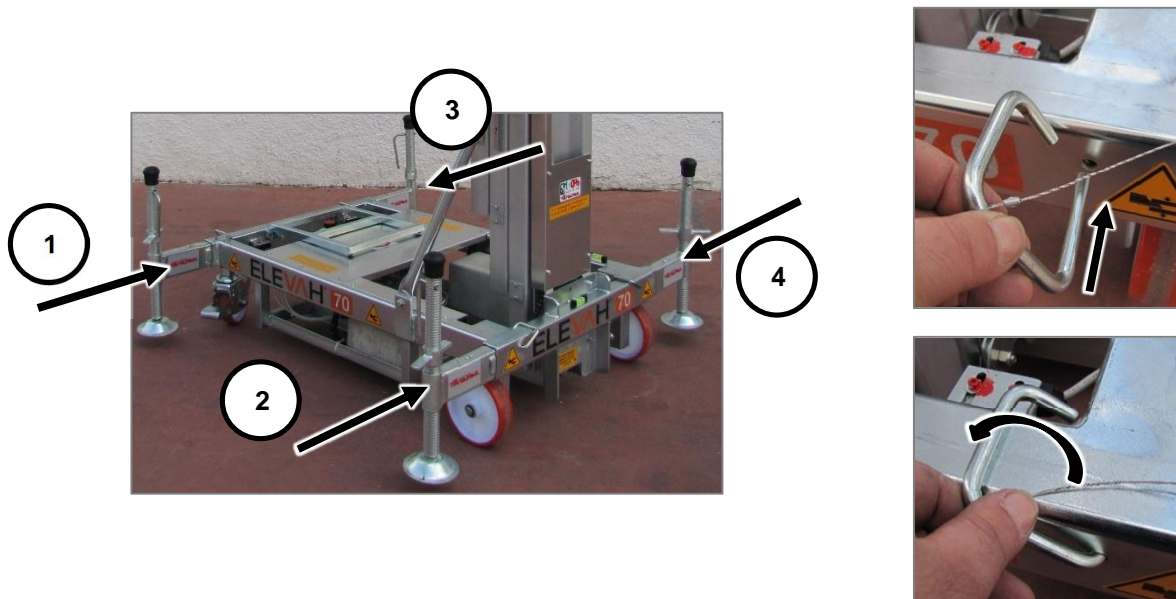





**ATTENTION**

**CHECK THE POSITION OF THE SPIRIT LEVEL BEFORE PROCEEDING WITH LIFTING THE WORK PLATFORM, BOTH WITH AND WITHOUT THE STABILISERS.  
 WHEN USING THE MACHINE WITHOUT STABILISERS AND WITH THE BASE NOT COMPLETELY LEVEL, AVOID LIFTING THE WORK PLATFORM TO PREVENT THE MACHINE FROM TIPPING OVER.**

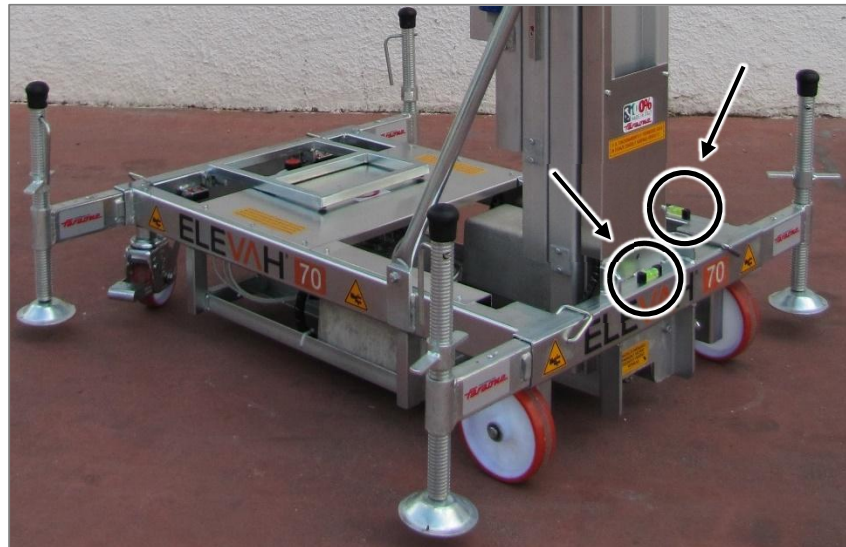

After adjusting the stabilisers by means of the handle, bring the locking ring to its stop to prevent accidentally loosening from the stabiliser foot (the ring must be secured to its stop towards the stabiliser support).





**ATTENTION**

**AFTER POSITIONING THE MACHINE AND MAKING SURE THE BASE IS LEVEL, INSERT THE BRAKES ON THE SWIVEL WHEELS IN ORDER TO PREVENT THE MACHINE FROM INVOLUNTARILY MOVING WHEN LIFTING/LOWERING THE WORK PLATFORM AND DURING OPERATIONS AT HEIGHTS.**

Lock the brakes of the wheels with your foot by pushing the lever marked by the wording “STOP”, bringing it to its limit switch in the lowest position (ATTENTION: do not use your hands).

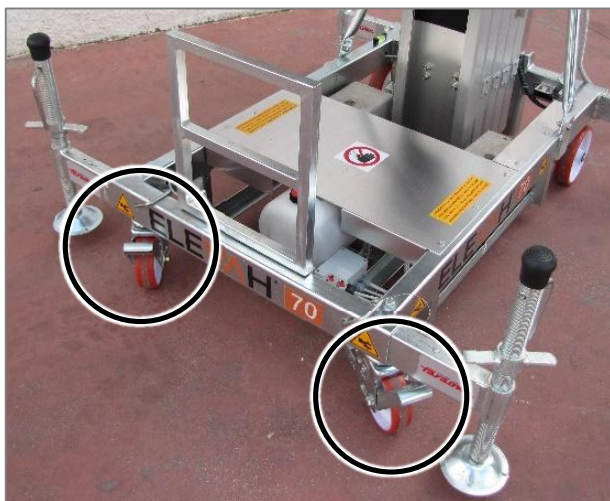

**NOTE:** To release the brakes, push the lever marked “FREE” with your foot (situated on the opposite side of the wheel), bringing the limit switch to its lowest position.

**Prohibition signs:**

Prohibition to overload the work platform beyond the limits indicated



Prohibition to use the machine as lifting equipment (forklift truck)



Prohibition to remove or tamper with the stability devices of the machine (sensors, ballasts, etc.)



Prohibition to remove or tamper with the safety and protection devices of the machine



Prohibition to climb on or off the work platform in places other than the arranged gate



Prohibition to increase outreach or work height of the mobile work aerial platform using additional equipment (for example, ladders)



Prohibition to induce oscillations on the machine so as not to make it unstable



Prohibition to install any addition device that increases the wind load on the mobile work aerial platform (for example, warning signs)



Prohibition to come into contact with live electrical conductors



Prohibition to climb up/down from the work platform when it is lifted



Prohibition to lift/lower the work platform without operator on board

When using the machine, the manufacturer recommends using the following personal protective equipment:



**Protection of the lower limbs**

**SLIP-PROOF SHOES**



**ATTENTION**

**THE USE OF ANY OTHER SPECIFIC PERSONAL PROTECTIVE DEVICES MUST BE CHECKED BASED ON THE ASSESSMENT OF SPECIFIC RISKS, CARRIED OUT BY THE EMPLOYER.**



**ATTENTION**

**ANY FENCING ENCLOSING THE MACHINE'S WORK AREA AND ANY ADDITIONAL SAFETY SIGNS TO BE USED FOR THAT AREA MUST BE VERIFIED BASED ON THE SPECIFIC RISK ASSESSMENT CARRIED OUT BY THE EMPLOYER.**



**ATTENTION**

**WITH THE REGARD TO THE ITALIAN LEGISLATION, THE LEGISLATIVE DECREE 81/2008 REQUIRES THE USE OF SUITABLE SAFETY BELTS IN THE CASE OF ALL EXTENDING BRIDGES AND SIMILAR.**

**THIS MEASURE APPLIES ALSO TO VERTICAL EXTENDING WORK PLATFORMS. A SPECIFIC RISK ASSESSMENT MUST BE CARRIED OUT BEFOREHAND TO DETERMINE THE NEED FOR A FALL PREVENTION SYSTEM.**



**SECTION 4. CONTROLS, LIGHTS AND MACHINE OPERATION****INTRODUCTION****ATTENTION**

**THE MANUFACTURER DOES NOT HAVE ANY DIRECT CONTROL OVER MACHINE APPLICATION AND OPERATION. THE USER AND THE OPERATOR ARE REQUIRED TO OBSERVE THE CORRECT SAFETY PROCEDURES.**

The ELEVAH 70 model lifting appliances are electric machines provided with an aerial work platform, assembled on a lifting mechanism with aluminium upright.

the lifting device is **INTENDED TO MOVE PERSONS TO THEIR WORK POSITIONS, FROM WHERE THEY CAN CARRY OUT THEIR TASKS FROM THE WORK PLATFORM.**

The main control station is located on the work platform. The operator can lift and lower the work platform from the work platform control console (the machine is not equipped with self-propelling, therefore shifting is by manual pushing, allowed only when the work platform is at the lowest position). If the operator on the platform is unable to lower it, use the ground control station's commands when servicing the machine or in an emergency. Vibrations generated by machines do not constitute any danger for the operator who is on the work platform. The level of continuous sound pressure (A measurement) on the work platform is less than 70 db (A).

**MACHINE OPERATION****Preliminary operations**

It is necessary for the following control conditions to be satisfied before activating the machine from the work platform controls.

- The voltage of the batteries, if present, must be sufficient enough to activate the machine (for 220 V external power, the plug must be connected to the electrical system).
- The main power switch on the ground control station must be switched on.
- Both emergency stop switches, one located on the ground control station and the other on the control console of the work platform, must be in RESTORE position.

**24 V BATTERY POWER SUPPLY**

If the machine is equipped with batteries, there is a battery charger with AC input/DC output. The battery charger stops charging automatically when the batteries are fully charged.

**ATTENTION**

**KEEP SPARKS, OPEN FLAMES OR LIT TOBACCO AWAY FROM THE BATTERIES. PROVIDE ADEQUATE VENTILATION DURING CHARGING. DO NOT CHARGE A FROZEN BATTERY.**

**NOTE:** *when the battery charger is connected to an a.c. socket, the transmission function of the machine is deactivated.*

**Battery charging procedure**

1. Park the machine in a well-ventilated area, near an a.c. electric socket;
2. Switch the machine off and remove the key from the door of the ground controls to prevent unauthorised use.
3. Connect the battery charger to a correctly installed socket and earthed according to current regulations.

**Battery charge status lights**

The battery charge status lights are next to the batteries unit installed on the machine.

The **RED LED**, when charging the battery, indicates the beginning of the charging cycle.

Charging finishes automatically without warning the operator, and is indicated by a **GREEN LED** coming on.

While using the machine, the battery status will switch from completely charged (*indicated by the green Led*), to the partially charged (*indicated by the orange Led*) to low battery (*indicated by the red Led*).

Carry out the following operations carefully:

- ✓ Charging must be carried out in a well-ventilated area, where it is forbidden to smoke and use open flames;
- ✓ It is recommended to avoid using any possible source of sparks near batteries charging.
- ✓ We recommend using anti-static clothing;
- ✓ Do not lift or tilt the batteries;
- ✓ Do not attempt to start the machine;

**ATTENTION**

**IT IS RECOMMENDED NOT TO LET THE BATTERIES GO COMPLETELY FLAT.**

**ATTENTION**

**WHEN THE MACHINE IS PUT OUT OF SERVICE FOR A LONG PERIOD, THE BATTERIES MUST BE COMPLETELY AND EVENLY CHARGED AT LEAST ONCE A WEEK AND KEPT WITH THE PLUG DISCONNECTED TO AVOID THE SAME BATTERIES GOING FLAT.**

**220 V POWER SUPPLY**

If the machine is equipped with a plug connecting it to a 220 V 50/60 Hz system, to power the machine it is sufficient to connect the power plug to an external electrical system.

**ATTENTION**

**CONNECT THE MACHINE TO A POWER SYSTEM THAT IS COMPLIANT WITH THE APPLICABLE LAW AND IN A GOOD MAINTENANCE CONDITION.**

**GROUND CONTROL STATION**

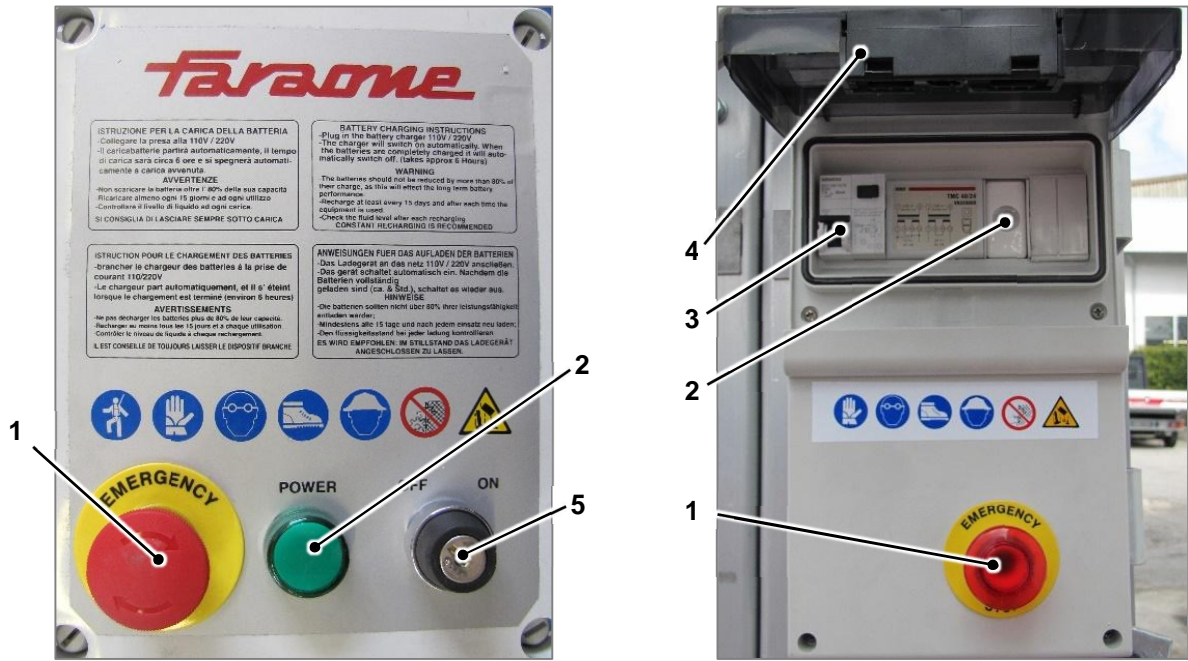

FOR MACHINES SUPPLIED WITH 24 V    FOR MACHINES SUPPLIED WITH 220 V

1. Emergency stop/switch-off button
2. LED power indicator
3. 220 V main power supply switch
4. Closable access door with lock
5. Main 24 V power supply switch with removable key

**Emergency stop/switch-off button**

**NOTE:** in order for the machine to operate, the emergency stop/switch off button on the machine must be on RESTORE.



**POWER SUPPLY DISCONNECTION**

PUSH INWARDS to engage the emergency stop.



**POWER SUPPLY CONNECTION**

TURN CLOCKWISE to restore the emergency stop.

(Note: if the machine is supplied by 220 V, simply pull the emergency button outwards to restore the control.)

**LED power indicator**

The LED is on if there is power.



**220 V main power supply switch**

The differential circuit breaker switch acts as the machine's main power switch and as a protection against power surges on the electrical mains to which the machine is connected, or against malfunctions that may arise on the machine's electrical system.

Move the lever switch upwards to switch it on. Move it downwards to cut the machine's power off.

**24 V main power supply switch**

The switch acts as the machine's main power switch. To supply power, turn the switch to "ON". To disconnect machine power supply, turn the switch to "OFF".

**PLATFORM CONTROL CONSOLE**

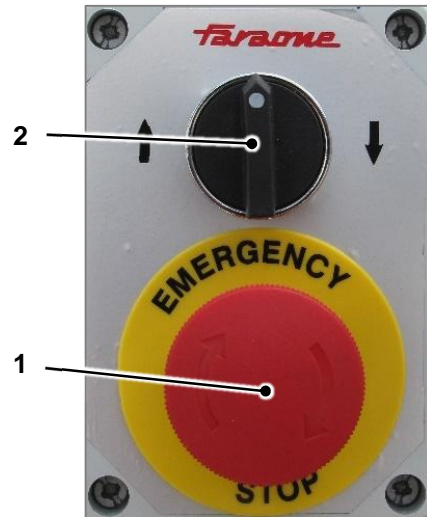

1. Emergency stop/switch-off button
2. Ascent/descent control switch

**General information**

Before actuating the machine from the control console of the work platform, it is necessary to satisfy the following conditions of the controls:

- Ground control station – The main power supply switch must be switched on.
- Ground control station - The Emergency stop/switch-off button must be in RESTORE position (POWER SUPPLY CONNECTED).
- Platform console - The emergency stop/switch-off button must be in RESTORE position (POWER SUPPLY CONNECTED).

**Emergency stop/switch-off button**

**NOTE:** in order for the machine to operate, the emergency stop/switch off button on the machine must be on RESTORE.



**POWER SUPPLY DISCONNECTION**

PUSH INWARDS to engage the emergency stop.



**POWER SUPPLY CONNECTION**

TURN CLOCKWISE to restore the emergency stop.  
 (Note: if the machine is supplied with 220 V, simply pull the emergency button outwards to restore the control.)

**Ascent/descent control switch**



TURN the switch to the RIGHT to make the work platform DESCEND.  
 TURN the switch to the LEFT to make the work platform ASCEND.

**ATTENTION**

**BEFORE LIFTING THE WORK PLATFORM, PAY ATTENTION TO WHAT IS STATED IN SECTION 3 "PREPARATION AND INSPECTION" WITH REGARD TO THE BASE LEVELLING CONTROL SYSTEM.**

**ATTENTION**

**BEFORE STARTING THE MACHINE, INSERT THE STABILISERS IN THE APPROPRIATE SEATS (UNTIL THEY STOP) AND LEVEL THE BASE BY ADJUSTING THE STABILISER'S FEET. PAY CAREFUL ATTENTION WHEN SLIGHTLY LIFTING THE MACHINE'S WHEELS SO THAT THEY REST ONLY ON THE STABILISER'S FEET.**

**ATTENTION**

**TO PREVENT UNAUTHORISED PERSONNEL FROM USING THE MACHINE'S GROUND CONTROL WHEN THE OPERATOR IS INSIDE THE WORK PLATFORM AT HEIGHTS, YOU MUST DO AS FOLLOWS BEFORE ENTERING THE PLATFORM:**

***24 V Powered machine***

**REMOVE THE MAIN POWER SUPPLY KEY AND KEEP IT IN A SAFE PLACE.**

***220 V Powered machine***

**CLOSE THE GROUND CONTROL ACCESS DOOR, REMOVE THE KEY AND KEEP IT IN A SAFE PLACE.**

**POSITIONS OF THE BASKET ASSEMBLY**

TWO WORK PLATFORM ASSEMBLY POSITIONS ARE AVAILABLE: STANDARD AND HIGH POSITION.

IF THE WORK PLATFORM IS INSTALLED IN A HIGH POSITION, YOU MUST USE THE FOLDING STEP SITUATED ABOVE THE BASE TO ACCESS THE PLATFORM.

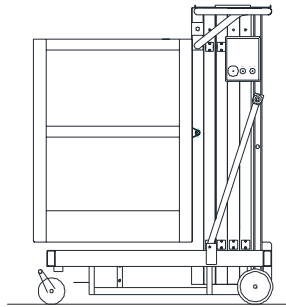

**STANDARD POSITION**

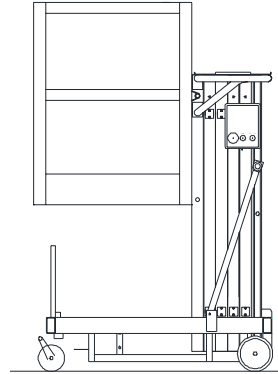

**HIGH POSITION**



**ATTENTION**

**WHEN THE WORK PLATFORM IS BEING REASSEMBLED, MAKE SURE YOU INSERT AND LOCK THE CONNECTING PIN TO THE STRUCTURE OF THE EXTENDIBLE COLUMN.**

Folding step opening:

1. Fold the step outwards from the machine;
2. Press it downwards to lock it.



**ATTENTION**

**BEFORE GOING UP ON THE STEP, MAKE SURE IT IS PROPERLY LOCKED.**



**ATTENTION**

**MAKE SURE THERE ARE NO OBSTACLES STOPPING THE WORK PLATFORM RAILING FROM CLOSING PROPERLY**



**ATTENTION**

**DO NOT RAISE/LOWER THE WORK PLATFORM IF THE RAILING ON THE WORK PLATFORM DOES NOT APPEAR TO CLOSE PROPERLY AND HAVE IT REPAIRED (CONTACT THE MANUFACTURER, IF NECESSARY)**



**ATTENTION**

**BEFORE STARTING THE MACHINE, INSERT THE STABILISERS IN THE APPROPRIATE SEATS (UNTIL THEY STOP) AND LEVEL THE BASE BY ADJUSTING THE STABILISER'S FEET. PAY CAREFUL ATTENTION WHEN SLIGHTLY LIFTING THE MACHINE'S WHEELS SO THAT THEY REST ONLY ON THE STABILISER'S FEET.**

**PARKING THE MACHINE**

1. Drive the machine in a well-protected and ventilated area.
2. Make sure the work platform is completely lowered, switching off the main power switch and extract the key.
3. Actuate both the front wheel locking brakes.

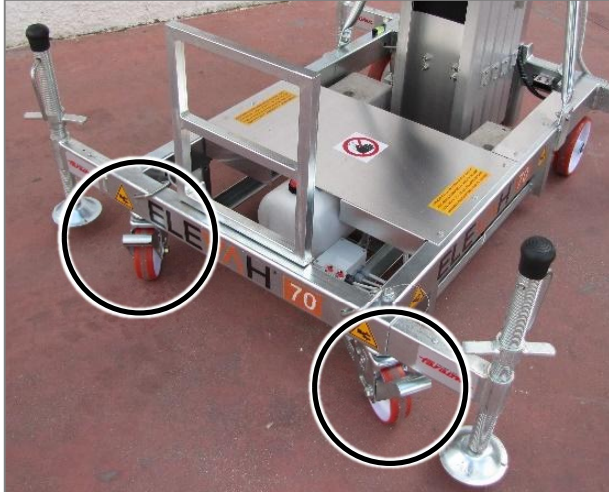

Lock the brakes of the wheels with your foot by pushing the lever marked by the wording "STOP", bringing it to its limit switch in the lowest position (ATTENTION: do not use your hands).

**NOTE:** To release the brakes, push the lever marked "FREE" with your foot (situated on the opposite side of the wheel), bringing the limit switch to its lowest position.



**ATTENTION**

**PREVENT UNAUTHORISED USE BY SWITCHING OFF THE MACHINE, SWITCHING OFF THE MAIN POWER SWITCH AND REMOVING THE KEY WHEN THE MACHINE IS NOT IN USE.**

**TRANSPORT AND LIFTING PROCEDURES**

**General information**

It is possible to transport the machine on to work premises using one of the following methods:

- By driving the machine along the route on its base wheels, if the surface it is travelling on allows it
- By moving it with a forklift (*check the gross weight of the machine in the Operational Technical Data Table for the machine*)



**ATTENTION**

**LOAD THE MACHINE ONTO A HEAVY DUTY VEHICLE HAVING A USEFUL LOAD CAPACITY ABLE TO SUPPORT THE TOTAL WEIGHT OF THE MACHINE (CHECK THE GROSS WEIGHT OF THE MACHINE IN THE OPERATIONAL TECHNICAL DATA TABLE OF THE MACHINE)**



**ATTENTION**

**FASTEN THE MACHINE SO THAT IT WILL NOT GET DAMAGED DURING TRANSPORT.**

**Handling with a forklift truck**

The machine can be lifted with a forklift truck. In this case, it must be held from the rear part of the machine in order to position it in a stable way onto the forks (see following figure).

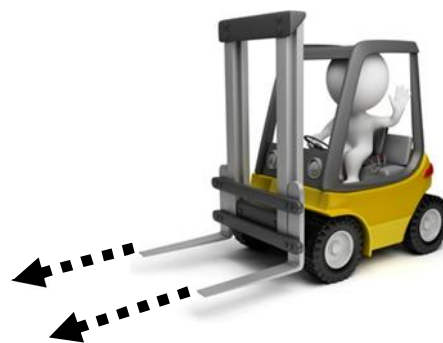

**ATTENTION**

**LIFT THE MACHINE ONLY WITH WORK PLATFORM FULLY LOWERED.**

**SECTION 5. EMERGENCY PROCEDURES**

This section shows the operations to be carried out in the event of an emergency during machine operation.

**EMERGENCY OPERATION**

**Operator unable to control the machine**

CONDITIONS IN WHICH THE MACHINE OPERATOR IS IMMOBILISED, TRAPPED OR UNABLE TO ACTIVATE OR CONTROL THE MACHINE.

- The other personnel must only operate the machine from the emergency controls on the ground in case of absolute need.
- The machine controls must only be used by qualified personnel. INTERRUPT MACHINE ACTIVITY IF THE CONTROLS DO NOT FUNCTION CORRECTLY.
- In case of incorrect operation of the controls or interruption of the electric power supply, the emergency stop must be activated and, if necessary, a qualified operator must carry out the EMERGENCY DESCENT phases from the ground.

Proceed as follows:

1. Activate the emergency button to disconnect the power supply;
2. ATTENTION: ensure there are no persons within the action range of the machine;
3. Gradually loosen the knurled knob installed underneath the base carriage near the extensible framework, in order to obtain the descent of the work platform (1);



4. ATTENTION: gradually loosen the knob and continuously supervise the entire descent phase of the work platform;
5. Once descent is completed, tighten the knob again;
6. Restore the emergency button to activate the machine's power supply.



**ATTENTION**

**THE OPERATIONAL PHASES OF THE EMERGENCY DESCENT ARE REPORTED ON APPROPRIATE ADHESIVE ABOVE THE EMERGENCY DESCENT CONTROL.**

**The work platform is locked in its overhead position**

If the work platform blocks or jams in overhead equipment or structures, transfer the person present on the work platform to a safe place before freeing the machine.

Recovery equipment can be used to allow the occupants to climb down from the working platform. To stabilise the machine movement use a crane or forklift.

**REPORTING THE ACCIDENT**

Faraone Industrie Spa must be immediately informed of any accidents to a Faraone product. Contact the factory by telephone and give all the necessary details, also in absence of injuries or evident damages to the property.

**ATTENTION**

**AFTER AN ACCIDENT, INSPECT THE ENTIRE MACHINE AND CHECK ALL FUNCTIONS. DO NOT LIFT THE WORKING PLATFORM UNTIL ONE IS SURE THAT ALL DAMAGES HAVE BEEN REPAIRED, AS REQUIRED, AND THAT ALL CONTROLS WORK PROPERLY.**

**SECTION 6. DAILY INSPECTION**

Start the full inspection from point (a), as set out in the following list. Proceed around the machine checking all listed conditions in sequence.

**ATTENTION**

**TO AVOID ANY INJURIES, ENSURE THAT THE MACHINE POWER SUPPLY IS SWITCHED OFF DURING "FULL INSPECTION".**

**DO NOT USE THE MACHINE BEFORE REPAIRING ALL FAULTS.  
DO NOT FAIL TO CARRY OUT A VISUAL INSPECTION OF THE LOWER PART OF THE BASE FRAME. ENSURE THE AREA IS CLEAR OF OBJECTS OR DEBRIS THAT MIGHT CAUSE SERIOUS DAMAGE TO THE MACHINE.**

**NOTE FOR INSPECTION:** *besides complying with the above criteria, ensure for each component that all parts are present, securely fixed and not loose and that there are no visible damage, leaks or signs of excessive wear.*

- (a) **Drive wheels/free wheels and swivel castors:** Check there is no debris on the wheels or around them;
- (b) **Base frame:** Ensure there are no loose wires or cables hanging underneath the base, check for any dents, rupture or cracks on the profiles;
- (c) **Manual descent control valve:** See note pertaining to functional check;
- (d) **Stabilisers (if present):** Check for dents on the aluminium profiles, breaks or cracks, and check operation of the adjustable stabiliser feet;
- (e) **Motor/pump/tank unit:** No conspicuous hydraulic leak, hydraulic oil filling level at the "full" line;
- (f) **Batteries (if present):** If necessary, charge them;
- (g) **Cage assembly and entrance doors:** Correct blocking of the cage and entrance doors operating correctly;
- (h) **Control console in the cage:** Controls secured, legible signs, emergency stop switch in the reset position and legible control signs;
- (i) **Ground control station (if present):** Main power supply selection switch operable, signs securely fastened and legible, emergency stop switch operable;
- (j) **Extendable structure unit:** Structure profiles, sliding inserts, chains, sequential activation cables, pulleys able to turn freely;
- (k) **Spirit levels (if present):** Check the integrity of the spirit levels on the base frame.

**ATTENTION**

**DO NOT USE THE MACHINE BEFORE REPAIRING ALL FAULTS / MALFUNCTIONS NOTED**

**SECTION 7. ROUTINE MAINTENANCE****ATTENTION**

**MAINTENANCE CAN BE CARRIED OUT BY COMPANY PERSONNEL WITH EXPERIENCE IN MAINTENANCE WORK AND ADEQUATELY TRAINED WITH REGARD TO SAFETY STANDARDS IN FORCE.**

**ATTENTION**

**IT IS RECOMMENDED TO ONLY USE SPARE PARTS APPROVED BY THE MANUFACTURER.**

**ATTENTION**

**CONTACT THE MANUFACTURER IF IN DOUBT OF THE FREQUENCY AND METHOD OF ROUTINE AND/OR EXTRAORDINARY MAINTENANCE ACTIVITIES.  
DO NOT TAKE INITIATIVES IF YOU ARE UNSURE OF WHAT YOU ARE DOING.**

**ATTENTION**

**TO CARRY OUT MAINTENANCE AND/OR CLEANING OPERATIONS ON THE MACHINE THAT REQUIRE THE EXTENDABLE STRUCTURE TO BE IN A PARTIALLY EXTENDED POSITION, ANCHOR THE CAGE SAFELY (FOR EXAMPLE, USING A CONTRASTING STRUT ON THE GROUND) TO PREVENT IT FROM ACCIDENTALLY FALLING ONTO THE OPERATOR PERFORMING THE MAINTENANCE OPERATIONS.**

**ATTENTION**

**THE RECOMMENDED FREQUENCY OF LUBRICATION AND OF THE WEAR CHECKS IS BASED ON NORMAL USE. IF THE MACHINE IS USED FOR HEAVY DUTY WORK, SUCH AS A HIGH NUMBER OF CYCLES, UNFAVOURABLE POSITION, CORROSIVE/DIRTY ENVIRONMENT, ETC., THE USER MUST INCREASE THE FREQUENCY OF THE CHECKS ACCORDINGLY.**

**MAINTENANCE EVERY THREE MONTHS**

- **Check there is no clearance, mechanical parts not correctly secured and/or bent and no parts/components desoldered;**
- **Check the integrity of the structural profiles;**
- **Check correct operation of the emergency descent valve.**  
Take the cage to a height and execute an “emergency descent”, as shown in the relative section of this manual.
- **Hydraulic Oil**  
Check the level of hydraulic oil and top-up, if necessary.  
Refer to the specifications described in the relative paragraph for information regarding hydraulic oil checks and top-up;
- **Check the hydraulic oil piping and make sure there are no leaks;**
- **Battery check (if applicable)**  
Periodically check for any corrosion and tightening of the terminals and any acid top-ups required in the battery (if a lead/acid type).
- **Check the cage and the entrance doors**  
Correct blocking of the cage and entrance doors operating correctly.
- **Check the controls present in the cage and on the ground (if applicable)**  
Controls secured, legible signs, main power supply operable selection switch, emergency stop switch in a reset position and legible control signs;
- **Check lubrication and wear of the lifting chains**  
When restoring lubrication, make sure the chains are not dirty or soiled with mud, rubble, ice or other foreign matter. Clean the chains thoroughly before lubricating them.  
The lifting chains must be lubricated with the extendable structure completely closed, by gravity, from the top, directly on the return wheels (if necessary, temporarily remove the protective cover to access the chains). For information regarding the wear of chains, refer to “Checks on the lifting chains”.
- **Check the wheels for wear**  
Check there is no debris on the wheels or around them. Check for wear or damage to the tread. The wheels must be replaced if the edges are worn or the profiles are deformed. If the wheels have significant damage on tread or sides, immediately assess the severity of the damage before operating the machine again.

**MAINTENANCE EVERY SIX MONTHS**

- **Lubrication of moving parts and sliding wheels check**

The extensions slide on runners fitted with nylon wheels. Four runners, two upper and two lower, are fitted for each pair of extensions. Three wheels are positioned on each runner, for a total of 12 for each pair of extensions. On each runner, one of the 3 wheels turns on an adjustable axis. This allows the wheels to be adjusted when they are worn thus giving rise to possible play of the moving extendable structure parts.

Contact the Manufacturer for further information and instructions regarding the adjustment of the sliding wheels of the extendable structure, when a backlash anomaly is found.

**MAINTENANCE EVERY TWO YEARS**

- **Hydraulic Oil**

Change the hydraulic oil in the tank.

Refer to the specifications described in the relative paragraph for information regarding hydraulic oil change.

**SECTION 8. MAINTENANCE OPERATING INSTRUCTIONS****BATTERY MAINTENANCE**

It is necessary to periodically check for any corrosion and tightening of the terminals.

Replace the batteries as follows:

1. Remove the cage;
2. Make sure the machine is not connected to the mains supply (charging batteries);
3. Use the suitable switch to disconnect the machine's power supply;
4. Open the protective cover of the battery compartment;
5. Loosen the connection terminals of the batteries (positive pole and negative pole);
6. Remove the batteries and replace them with new ones;
7. Connect the terminals of the batteries, making sure to do so correctly (red wire for the positive pole, black wire for the negative pole) and tighten them;
8. Close and lock the protective cover;
9. Position the cage again in the desired position, as indicated in paragraph 4 "POSITIONS OF THE BASKET ASSEMBLY", being careful to insert and lock the connecting pin correctly to the structure of the extendible column;
10. Reconnect the power supply.

**ATTENTION**

**SHOULD THE BATTERY BE DAMAGED, USE THE RELATIVE PERSONAL PROTECTIVE EQUIPMENT TO PROTECT YOUR HANDS AGAINST CHEMICAL AGGRESSION WHEN REPLACING THE BATTERY.**

**DISPOSE OF THE BATTERIES IN ACCORDANCE WITH THE LAWS IN FORCE.  
REPLACE THE BATTERIES WITH THE SAME TYPES AS THOSE SUPPLIED BY THE MANUFACTURER.**

**HYDRAULIC OIL CHANGE**

Faraone Industrie Spa recommends using hydraulic oil with viscosity index 32. Mixing oils of different makes or types is strongly ill advised, since they may not contain the necessary additives or viscosity may be different.

**ATTENTION**

**THE HYDRAULIC OIL MUST BE TOPPED UP/CHANGED WITH THE CAGE FULLY DOWN; IF THE HYDRAULIC OIL TANK IS UNDER THE CAGE, KEEP IT AT A HEIGHT OF APPROXIMATELY ONE METRE AND TOP UP/CHANGE IT.**

**ATTENTION**

**DISPOSE OF THE WASTE OIL IN ACCORDANCE WITH THE LAWS IN FORCE.**

---

**CHECKS ON LIFTING CHAINS**

---

**1) Chain noise**

A grinding metal noise will be heard if the chains are not fully lubricated. This causes metal-metal friction between the joints of the chain, which can lead to seizing-slipping effect, causing the work platform to move unevenly.

**2) Surface rust**

Plates with rusty surfaces are easily recognisable by the typical brown colour. Rust can lead to chain fatigue failures.

**3) Rust on joints**

Corroded connection points are recognisable by their red-brown colour. This phenomenon may arise from lack of lubrication or use of grease and oil unsuitable for penetrating the joints.

**4) Stiff joints**

Any joint that is not in a straight position when leaving the return pulley, can no longer be used. This phenomenon may be caused by corrosion or cold micro welding.

**5) Turned pins**

This is the consequence of incorrect lubrication and the aforementioned phenomenon of stiffened joints. This phenomenon is easily recognised by the difference in the pin clinching positions compared to factory standard.

**6) Pins coming out of their housings**

A direct consequence of the stiff joints of turned pins.

**7) Wear**

It is important to assess whether the connection plates are very worn.

**8) Broken plates**

This is the result of fatigue failure caused by overloading. Corrosion phenomena may contribute to this problem.

**9) Broken pins**

This problem usually occurs as a result of corrosion in the chain joints. Since the pins of a single chain are subject to the same load and corrosion conditions, one failure is usually followed by more. Experience has shown that this type of failure is not always easily recognised as there are no evident changes in the chain conditions, especially in the initial stage.



**Checking for chain wear**

(Check the cause of the malfunction before installing the new chain)

*Lifting chain*

Manufacturer: REGINA – Model: AL544

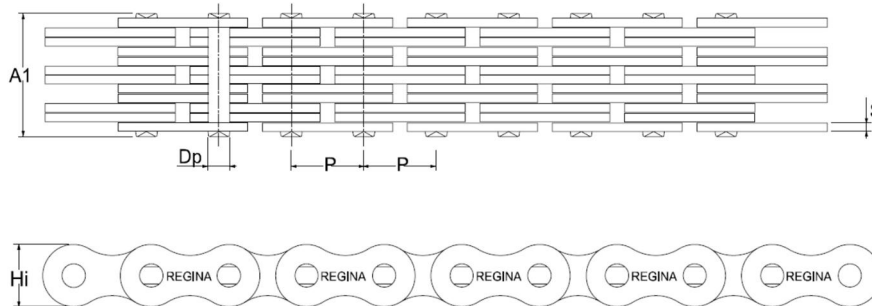

$A1 = 19.1 \text{ mm}$  ;  $Dp = 5.09 \text{ mm}$  ;  $P = 15.875 \text{ mm}$  ;  $S = 2.04 \text{ mm}$  ;  $Hi = 12.83 \text{ mm}$

*Elongation:*

Measurement of chain slightly tightened on straight sections 1/5 to 1/15 of the total length. Maximum elongation allowed: 2% along the most worn section.

*Wear of plate profiles:*

Where the phenomenon is most noticeable: maximum permitted height reduction of 2.5% on one side only, 4% if on two sides, in relation to the initial height.

*Wear on the side of the chain:*

Replace the chain if the protruding part of the pin heads is worn down by more than 25% or if the outer side is worn down by more than 20% of its thickness.



**ATTENTION**

**FOR FURTHER INFORMATION REGARDING PURCHASE OF SPARE PARTS AND CONSUMABLES, PLEASE CONTACT THE MANUFACTURER.**

**THE MANUFACTURER DECLINES ALL LIABILITY DUE TO DAMAGE OR MALFUNCTION CAUSED BY USE OF PARTS NOT AUTHORISED BY THE SAID MANUFACTURER.**

**SECTION 9. ATTACHED DOCUMENTATION**









- ✓ ATTACHMENT 1 – Layout for the application of the stickers;
- ✓ ATTACHMENT 2 – Version 24 V hydraulic diagram;
- ✓ ATTACHMENT 3 – Version 220 V hydraulic diagram;
- ✓ ATTACHMENT 4 – Version 24 V wiring diagram;
- ✓ ATTACHMENT 5 – Version 220 V wiring diagram;
- ✓ ATTACHMENT 6 – Inspection certificate;
- ✓ ATTACHMENT 7 – Declaration of conformity.



**ATTENTION**

**SHOULD THE MACHINE BE TRANSFERRED TO A THIRD PARTY, ALL DOCUMENTATION MUST BE DELIVERED WITH THE SAME.**

**ATTACHMENT 1 – Layout for the application of the stickers**

Pos.	SYMBOL	DESCRIPTION	Pos.	SYMBOL	DESCRIPTION
1		<b><u>DANGER SIGN</u></b> CRUSHING AND TRAPPING OF THE LOWER LIMBS	2		<b><u>DANGER SIGN</u></b> CRUSHING AND TRAPPING OF THE UPPER LIMBS
3		<b><u>DANGER SIGN</u></b> POSSIBILITY OF IMPACT	4		<b><u>PROHIBITION SIGN</u></b> FOR UNAUTHORISED PERSONNEL TO USE THE MACHINERY
5		<b><u>PROHIBITION SIGN</u></b> TO REMOVE THE SAFETY PROTECTIONS AND DEVICES	6		<b><u>OBLIGATION SIGN</u></b> CONSULT THE OPERATING MANUAL
7		<b><u>OBLIGATION SIGN</u></b> WEAR NON-SLIP SHOES	8	<b><u>INDICATION</u></b>	“DO NOT MOVE THE MACHINE WITH CAGE LIFTED”
9	<b><u>INDICATION</u></b>	“EMERGENCY DESCENT”	10	<b><u>INDICATION</u></b>	“EMERGENCY DESCENT PROCEDURE”
11	<b><u>INDICATION</u></b>	“DANGERS AND PROHIBITIONS IN USING THE PLATFORM”	12	<b><u>INDICATION</u></b>	“USE OF THE PLATFORM WITH STABILISERS”
13	<b><u>INDICATION</u></b>	“HOLDING ONLY 1 PERSON”	14	<b><u>INDICATION</u></b>	“INTERNAL USE AND IN THE ABSENCE OF WIND”
15	<b><u>INDICATION</u></b>	 200 KG	16	<b><u>INDICATION</u></b>	“MAX 20 KG”

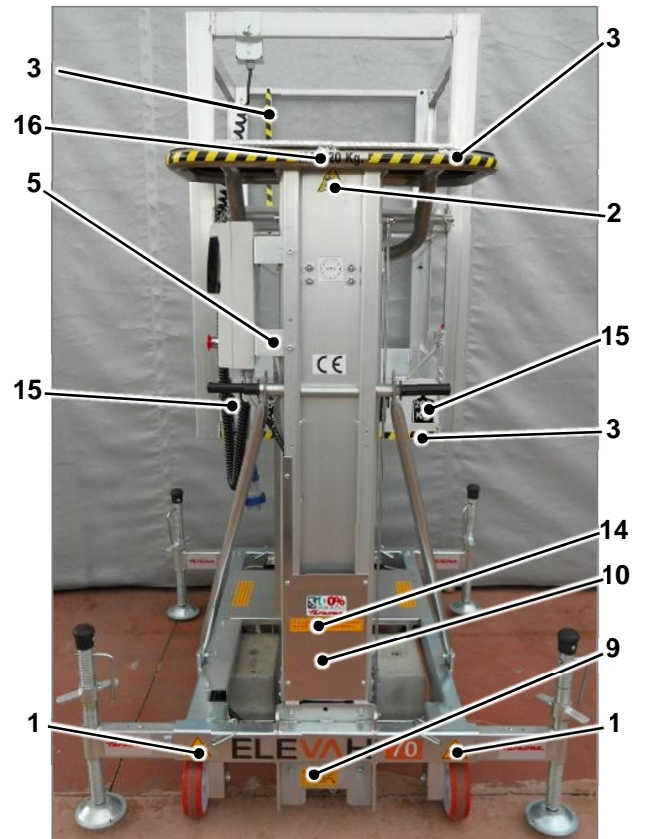
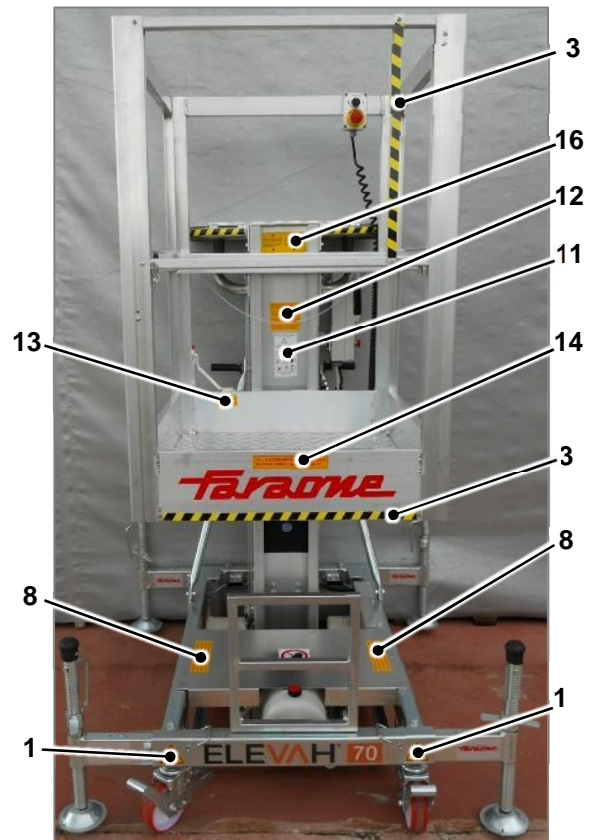





**ATTACHMENT 4 – Version 24 V Wiring diagram**

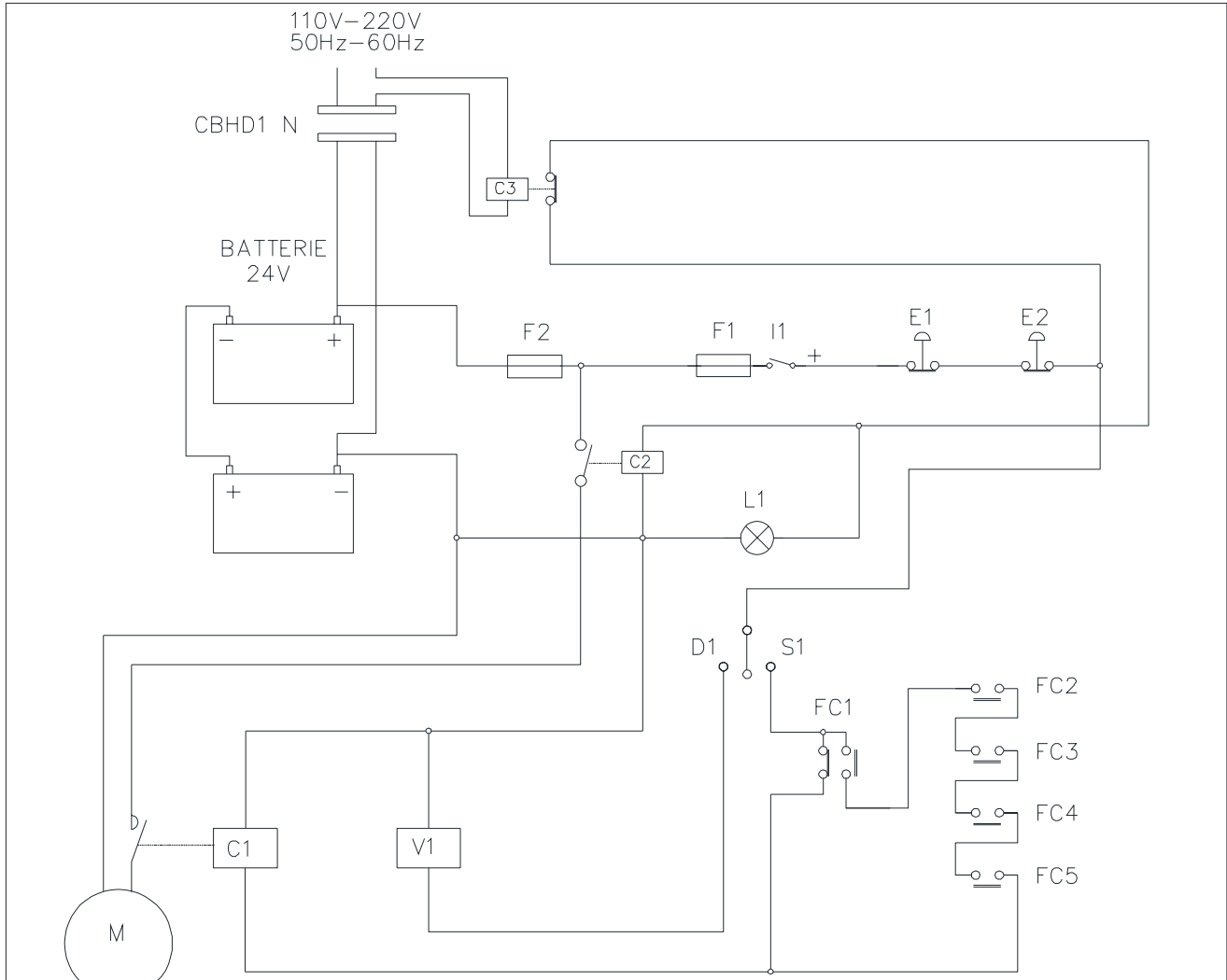

MORSETTIERA

	+	-	1	2	3	4	5	6
F1	+	-	L1	D			S	
	24V	24V						

**LEGENDA**

I1 INTERRUTTORE PRINCIPALE  
 S1 COMANDO CESTELLO SU'  
 S2 COMANDO CESTELLO GIU'  
 F1 FUSIBILE 2A  
 F2 FUSIBILE 100A  
 E1 EMERGENZA QUADRO  
 E2 EMERGENZA CESTELLO  
 L1 SPIA VERDE PRESENZA TENSIONE  
 C1 CONTATTORE MOTORE  
 C2 CONTATTORE LINEA  
 C3 RELE' CARICABATTERIE  
 M MOTORE  
 V1 VALVOLA IDRAULICA  
 L2 SPIA ROSSA EMERGENZA  
 FC1 MICRO LUNGO COLONNA  
 FC2-FC5 MICRO STABILIZZATORI  
 CBHD1 N CARICABATTERIE

**DESCRIPTION**

I1 MAIN SWITCH  
 S1 RISE CONTROL  
 S2 DESCENT CONTROL  
 F1 FUSE 2A  
 F2 FUSE 100A  
 E1 EMERGENCY LOWERING ON CONTROL PANEL  
 E2 EMERGENCY LOWERING ON THE CAGE  
 L1 POWER GREEN LIGHT  
 C1 ENGINE CONTACTOR  
 C2 LINE CONTACTOR  
 C3 BATTERY CHARGER RELAY  
 M ENGINE  
 V1 HYDRAULIC VALVE  
 L2 RED EMERGENCY LIGHT  
 FC1 CONTROL ON THE MAST  
 FC2-FC5 STABILISER CONTROL  
 CBHD1 N BATTERY CHARGER

OGGETTO **SCHEMA ELETTRICO PIATTAFORMA ELEVVAH70 A 24V**

**IMA** SPA  
 Tortoreto (TE) Italy  
 tel+39086177221  
 fax+390861772222  
 www.faraone.com

**FARAONE**  
 info@faraone.com

DATA: 01.03.2015  
 REV. 01

QUESTO DISEGNO E' DI PROPRIETA' IMA spa: NESSUNA RIPRODUZIONE E' CONSENTITA SENZA LA NOSTRA AUTORIZZAZIONE

**ATTACHMENT 5 – Version 220 V wiring diagram**

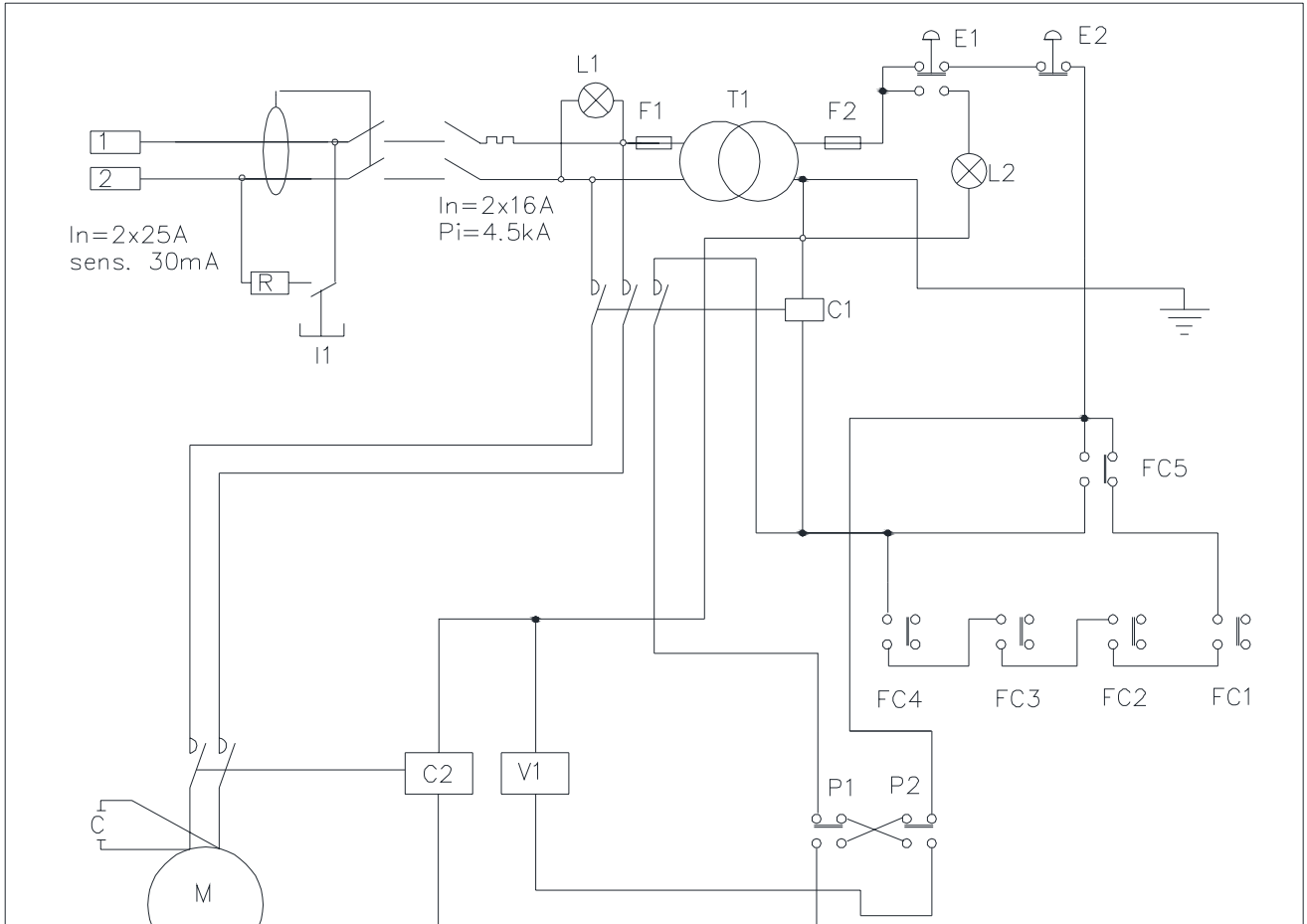

MORSETTIERA

PE	L	N	1	2	3	4
			0 24V	V 24		

LEGENDA

- I1 INTERRUTTORE DIFFERENZIALE MAGNETOTERMICO
- P1 PULSANTE CESTELLO SU'
- P2 PULSANTE CESTELLO GIU'
- T1 TRASFORMATORE 50 VA 220/24V
- F1 FUSIBILE 0.5A
- F2 FUSIBILE 2A
- FC1 – FC4 MICRO STABILIZZATORI
- FC5 MICRO LUNGO COLONNA
- L1 SPIA VERDE PRESENZA TENSIONE
- L2 SPIA ROSSA EMERGENZA AL QUADRO
- E1 EMERGENZA QUADRO
- E2 EMERGENZA CESTELLO
- C1 CONTATTORE PRINCIPALE
- C2 CONTATTORE MOTORE
- M MOTORE
- V1 VALVOLA IDRAULICA
- C CONDENSATORE

SCHEMA ELETTRICO PIATTAFORMA ELEVVAH70 A 220V

**IMA** SPA  
 Tortoreto (TE) Italy  
 tel+39086177221  
 fax+39086177222  
 www.faraone.com

**Faraone**  
 info@faraone.com

DATA: 01.03.2015  
 REV. 01

QUESTO DISEGNO E' DI PROPRIETA' IMA spa: NESSUNA RIPRODUZIONE E' CONSENTITA SENZA LA NOSTRA AUTORIZZAZIONE

**ATTACHMENT 6 - Inspection certificate**

# AERIAL PLATFORM

## ELEVAH 70

Serial number:

The machine, built in compliance with the model that is the object of type testing, underwent the following tests:

- Brake test
- Overload test
- Operation test

Producing a POSITIVE result.

Tortoreto, on date



**ATTACHMENT 5 – Declaration of conformity**



**FARAONE INDUSTRIE SPA**  
Via San Giovanni, 20 - C.da Salino  
64018 Tortoreto (TE) ITALY  
Tel. +39 0861.772221  
Fax +39 0861.772222

[www.faraone.com](http://www.faraone.com)  
[info@faraone.com](mailto:info@faraone.com)  
REA 92848 CCIAA TE  
P.IVA e C.F. IT 00732060678  
C.S. euro 2.000.000 i.v.

**DICHIARAZIONE DI CONFORMITA'-DECLARATION OF CONFORMITY  
DECLARATION DE CONFORMITE' – EG KONFORMITÄTSERKLÄRUNG**



Macchina/Machine/Machine/Maschine	<b>Piattaforma aerea/Aerial platform Plateforme aérienne/Arbeitsbühne</b>
Modello/Model/Modèle/Modell	<b>XXXXXXXXXXXX</b>
Matricola/Serial No. Numéro sérial/Laufende Nr.	<b>XXXX/XXXX</b>
Anno/Year/Année/Jahr	<b>XXXX</b>

Il sottoscritto Faraone Pier Giuseppe, in qualità di legale rappresentante della ditta FARAONE INDUSTRIE S.p.A. – C.da Salino, Tortoreto (Italia), Costruttore, nonché persona giuridica autorizzata a costituire il fascicolo tecnico per la macchina in oggetto DICHIARA CHE la piattaforma aerea è stata fabbricata conformemente ai requisiti di sicurezza e salute previsti dalla Direttiva Macchine 2006/42/CE ed alle norma armonizzata UNI EN 280:2015 ed è stata testata dal nostro laboratorio interno.

Il Fascicolo Tecnico di costruzione è conservato presso la FARAONE INDUSTRIE S.p.A.

Il Fascicolo Tecnico e la versione originale delle istruzioni di uso e manutenzione vengono redatti in lingua italiana.

The undersigned Faraone Pier Giuseppe, as legal representative of the company FARAONE INDUSTRIE S.p.A. – C.da Salino, Tortoreto (Italy), manufacturer, as well as a legal person authorized to compile the technical file for the machine in question, DECLARES THAT, the aerial platform has been manufactured in accordance with the requirements of safety and health of the Machine Directive 2006/42/CE and harmonized standard EN 280:2015 and has been tested from our internal laboratory.

The technical reference of the platform are kept in the records of FARAONE INDUSTRIE S.p.A.

The technical file and the original version of the user's manual are written in Italian.

Le soussigné Faraone Pier Giuseppe, agissant en tant que représentant légal de la société FARAONE INDUSTRIE S.p.A. – C.da Salino, Tortoreto (Italie), fabricant, ainsi qu'une personne morale autorisée à constituer le dossier technique de la machine en question DECLARE QUE, la plate-forme élévatrice susmentionnée a été fabriqué en conformité avec les critères de sécurité et de la santé de la Directive Machines 2006/42/CE et la norme harmonisée EN 280:2015 et testé par notre laboratoire interne.

Le dossier technique de construction est entreposé chez FARAONE INDUSTRIE S.p.A.

Le dossier technique et la version originale des instructions de fonctionnement et d'entretien sont écrits en italien.

Der unterzeichnete Faraone Pier Giuseppe, als gesetzlicher Vertreter der Firma FARAONE INDUSTRIE S.p.A. – C.da Salino, Tortoreto (Italien), sowie Hersteller und Person die bevollmächtigt ist die technischen Unterlagen für die o.g. Maschine zusammenzustellen, ERKLÄRT dass die Hubarbeitsbühne nach den Sicherheits- und Gesundheitsanforderungen der Maschinenrichtlinie 2006/42/EG und der harmonisierten Norm EN280:2015 gefertigt wurde und von unserem internen Labor getestet worden ist.

Die technischen Bauunterlagen werden bei FARAONE INDUSTRIE S.p.A. aufbewahren.

Die technischen Unterlagen und die ursprüngliche Version der Bedienungs- und Wartungsanleitungen sind in Italienisch geschrieben.

Tortoreto, XX/XX/XXXX

Il Legale Rappresentante  
(Faraone Pier Giuseppe)

**FARAONE**  
Industrie spa  
C.da Salino - Via San Giovanni, 20  
64018 TORTORETO (Te) - Tel. 0861.77221  
Fax 0861.77222 - P.IVA 0073206078





**MAINTENANCE**

OPERATOR: \_\_\_\_\_

DATE: \_\_\_\_\_

	DONE	
	✓	✗
<b><u>Every three months</u></b>		
Check there is no clearance, mechanical parts not correctly secured and/or bent and no parts/components desoldered		
Check the integrity of the structural profiles		
Check correct operation of the emergency descent valve		
Check the level of hydraulic oil		
Check the hydraulic oil piping and make sure there are no leaks		
Check the Battery		
Check the cage and the entrance doors		
Check the controls		
Check the lifting chains		
Check the wheels for wear		

**Every six months**

Perform the "THREE-MONTHLY" checks		
Lubrication of moving parts		
Check the sliding wheels		

**Every two years**

Perform the "THREE-MONTHLY, SIX-MONTHLY AND ANNUAL" checks		
Hydraulic oil change		

Date: \_\_\_\_\_

Signature: \_\_\_\_\_

NOTE	
------	--

**MAINTENANCE**

OPERATOR: \_\_\_\_\_

DATE: \_\_\_\_\_

	DONE	
	✓	✗
<b><u>Every three months</u></b>		
Check there is no clearance, mechanical parts not correctly secured and/or bent and no parts/components desoldered		
Check the integrity of the structural profiles		
Check correct operation of the emergency descent valve		
Check the level of hydraulic oil		
Check the hydraulic oil piping and make sure there are no leaks		
Check the Battery		
Check the cage and the entrance doors		
Check the controls		
Check the lifting chains		
Check the wheels for wear		

**Every six months**

Perform the "THREE-MONTHLY" checks		
Lubrication of moving parts		
Check the sliding wheels		

**Every two years**

Perform the "THREE-MONTHLY, SIX-MONTHLY AND ANNUAL" checks		
Hydraulic oil change		

Date: \_\_\_\_\_

Signature: \_\_\_\_\_

NOTE	
------	--

**MAINTENANCE**

OPERATOR: \_\_\_\_\_

DATE: \_\_\_\_\_

	DONE	
	✓	✗
<b><u>Every three months</u></b>		
Check there is no clearance, mechanical parts not correctly secured and/or bent and no parts/components desoldered		
Check the integrity of the structural profiles		
Check correct operation of the emergency descent valve		
Check the level of hydraulic oil		
Check the hydraulic oil piping and make sure there are no leaks		
Check the Battery		
Check the cage and the entrance doors		
Check the controls		
Check the lifting chains		
Check the wheels for wear		

**Every six months**

Perform the "THREE-MONTHLY" checks		
Lubrication of moving parts		
Check the sliding wheels		

**Every two years**

Perform the "THREE-MONTHLY, SIX-MONTHLY AND ANNUAL" checks		
Hydraulic oil change		

Date: \_\_\_\_\_

Signature: \_\_\_\_\_

NOTE
------

**MAINTENANCE**

OPERATOR: \_\_\_\_\_

DATE: \_\_\_\_\_

**Every three months**

	DONE	
	✓	✗
Check there is no clearance, mechanical parts not correctly secured and/or bent and no parts/components desoldered		
Check the integrity of the structural profiles		
Check correct operation of the emergency descent valve		
Check the level of hydraulic oil		
Check the hydraulic oil piping and make sure there are no leaks		
Check the Battery		
Check the cage and the entrance doors		
Check the controls		
Check the lifting chains		
Check the wheels for wear		

**Every six months**

Perform the "THREE-MONTHLY" checks		
Lubrication of moving parts		
Check the sliding wheels		

**Every two years**

Perform the "THREE-MONTHLY, SIX-MONTHLY AND ANNUAL" checks		
Hydraulic oil change		

Date: \_\_\_\_\_

Signature: \_\_\_\_\_

NOTE	
------	--

**MAINTENANCE**

OPERATOR: \_\_\_\_\_

DATE: \_\_\_\_\_

**Every three months**

	DONE	
	✓	x
Check there is no clearance, mechanical parts not correctly secured and/or bent and no parts/components desoldered		
Check the integrity of the structural profiles		
Check correct operation of the emergency descent valve		
Check the level of hydraulic oil		
Check the hydraulic oil piping and make sure there are no leaks		
Check the Battery		
Check the cage and the entrance doors		
Check the controls		
Check the lifting chains		
Check the wheels for wear		

**Every six months**

Perform the "THREE-MONTHLY" checks		
Lubrication of moving parts		
Check the sliding wheels		

**Every two years**

Perform the "THREE-MONTHLY, SIX-MONTHLY AND ANNUAL" checks		
Hydraulic oil change		

Date: \_\_\_\_\_

Signature: \_\_\_\_\_

NOTE



**MAINTENANCE**

OPERATOR: \_\_\_\_\_

DATE: \_\_\_\_\_

	DONE	
	✓	✗
<b><u>Every three months</u></b>		
Check there is no clearance, mechanical parts not correctly secured and/or bent and no parts/components desoldered		
Check the integrity of the structural profiles		
Check correct operation of the emergency descent valve		
Check the level of hydraulic oil		
Check the hydraulic oil piping and make sure there are no leaks		
Check the Battery		
Check the cage and the entrance doors		
Check the controls		
Check the lifting chains		
Check the wheels for wear		

**Every six months**

Perform the "THREE-MONTHLY" checks		
Lubrication of moving parts		
Check the sliding wheels		

**Every two years**

Perform the "THREE-MONTHLY, SIX-MONTHLY AND ANNUAL" checks		
Hydraulic oil change		

Date: \_\_\_\_\_

Signature: \_\_\_\_\_

NOTE	
------	--

**MAINTENANCE**

OPERATOR: \_\_\_\_\_

DATE: \_\_\_\_\_

**Every three months**

	DONE	
	✓	✗
Check there is no clearance, mechanical parts not correctly secured and/or bent and no parts/components desoldered		
Check the integrity of the structural profiles		
Check correct operation of the emergency descent valve		
Check the level of hydraulic oil		
Check the hydraulic oil piping and make sure there are no leaks		
Check the Battery		
Check the cage and the entrance doors		
Check the controls		
Check the lifting chains		
Check the wheels for wear		

**Every six months**

Perform the "THREE-MONTHLY" checks		
Lubrication of moving parts		
Check the sliding wheels		

**Every two years**

Perform the "THREE-MONTHLY, SIX-MONTHLY AND ANNUAL" checks		
Hydraulic oil change		

Date: \_\_\_\_\_

Signature: \_\_\_\_\_

NOTE
------

**MAINTENANCE**

OPERATOR: \_\_\_\_\_

DATE: \_\_\_\_\_

**Every three months**

	DONE	
	✓	✗
Check there is no clearance, mechanical parts not correctly secured and/or bent and no parts/components desoldered		
Check the integrity of the structural profiles		
Check correct operation of the emergency descent valve		
Check the level of hydraulic oil		
Check the hydraulic oil piping and make sure there are no leaks		
Check the Battery		
Check the cage and the entrance doors		
Check the controls		
Check the lifting chains		
Check the wheels for wear		

**Every six months**

Perform the "THREE-MONTHLY" checks		
Lubrication of moving parts		
Check the sliding wheels		

**Every two years**

Perform the "THREE-MONTHLY, SIX-MONTHLY AND ANNUAL" checks		
Hydraulic oil change		

Date: \_\_\_\_\_

Signature: \_\_\_\_\_

NOTE
------

**MAINTENANCE**

OPERATOR: \_\_\_\_\_

DATE: \_\_\_\_\_

	DONE	
	✓	✗
<b><u>Every three months</u></b>		
Check there is no clearance, mechanical parts not correctly secured and/or bent and no parts/components desoldered		
Check the integrity of the structural profiles		
Check correct operation of the emergency descent valve		
Check the level of hydraulic oil		
Check the hydraulic oil piping and make sure there are no leaks		
Check the Battery		
Check the cage and the entrance doors		
Check the controls		
Check the lifting chains		
Check the wheels for wear		

**Every six months**

Perform the "THREE-MONTHLY" checks		
Lubrication of moving parts		
Check the sliding wheels		

**Every two years**

Perform the "THREE-MONTHLY, SIX-MONTHLY AND ANNUAL" checks		
Hydraulic oil change		

Date: \_\_\_\_\_

Signature: \_\_\_\_\_

NOTE	
------	--





Faraone Industrie Spa  
Contrada Salino – Via San Giovanni, 20  
64018, Tortoreto (TE) – ITALY  
Tel.: +39.0861.77.22.21 – fax: +39.0861.77.22.22  
[www.faraone.com](http://www.faraone.com)  
[info@faraone.com](mailto:info@faraone.com)